



**OIL COOLER KIT
INSTALLATION INSTRUCTIONS**

D570-0821

Application: 2011-12 E82/E88 135 (N55) with stock oil cooler

PARTS LIST

<u>Qty</u>	<u>Part No.</u>	<u>Description</u>
1	D573-0039	Oil Cooler + Frame Assy
1	D573-0044	Oil Line Mount with O-rings
1	D572-0059	AC Line Support Bracket
1	D373-0023	Oil Cooler Hose Inner
1	D373-0018	Oil Cooler Hose Outer
1	D573-0059	Hardware Kit consisting of the following items;
	1 D670-0206	#22 Loop Clamp
	1 D670-0209	Double-Wide Loop Clamp
	1 D670-0217	3/4" Loop Clamp ADD THESE
	2 D670-0226	Hose Pairing Clamps
	1 M8x25 allen	M8x25x1.25p allen bolt
	1 D671-0526	M8 locking flange nut
	1 M8 Schnorr	M8 ribbed washer
	1 M6 x 16	M6 x 16 bolt
	1 M6 NYLOK	M6 nylok nut
	1 M6 WAVE	M6 wave washer
	5 D502151	11" wire ties
	1 36 20 6 774 888	Plastic Rivet

Tools needed:

Die grinder and rotary bits

Fiberglass cutting disc for die grinder

Hacksaw

Belt sander (advisable)

Drill and bits

1. Raise the car and remove the front wheels.
2. Refer to TIS document # 17 11 150 for removing the stock oil cooler.
3. Remove the left side front wheel well liner.
4. Remove the doors for the headlight cleaning system if your car is equipped with them. Pull out spray nozzle (1) by cover (2). Hold spray nozzle and carefully unclip cover sideways and remove. **Important! Do not let go of Spray Nozzle when removing Cover!** Grip spray nozzle firmly. **See figure below. This step is best done with two people.**

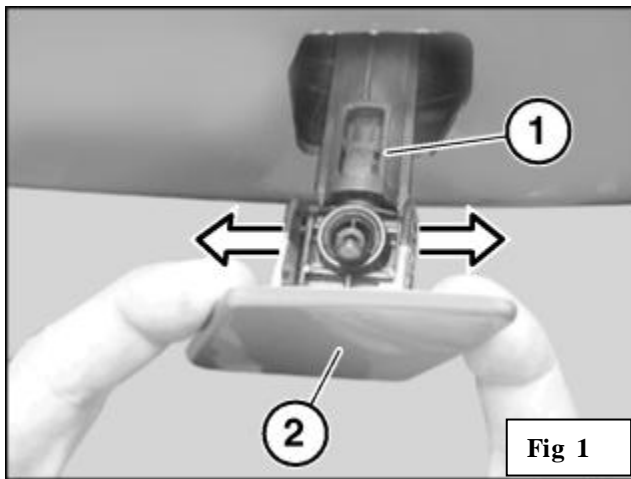

5. Remove the right side (passenger side) brake duct. This part will be reinstalled after trimming it to accommodate the new larger Oil Cooler.
6. Cut off the small raised section of the plastic front panel as shown below (dotted line) using a hacksaw blade and/or a fiberglass cutting disc held in a die-grinder (disregard the cut-open wheel well liner in this view). Note that there is a small piece of sheet metal inside this piece of plastic.

Fig 2

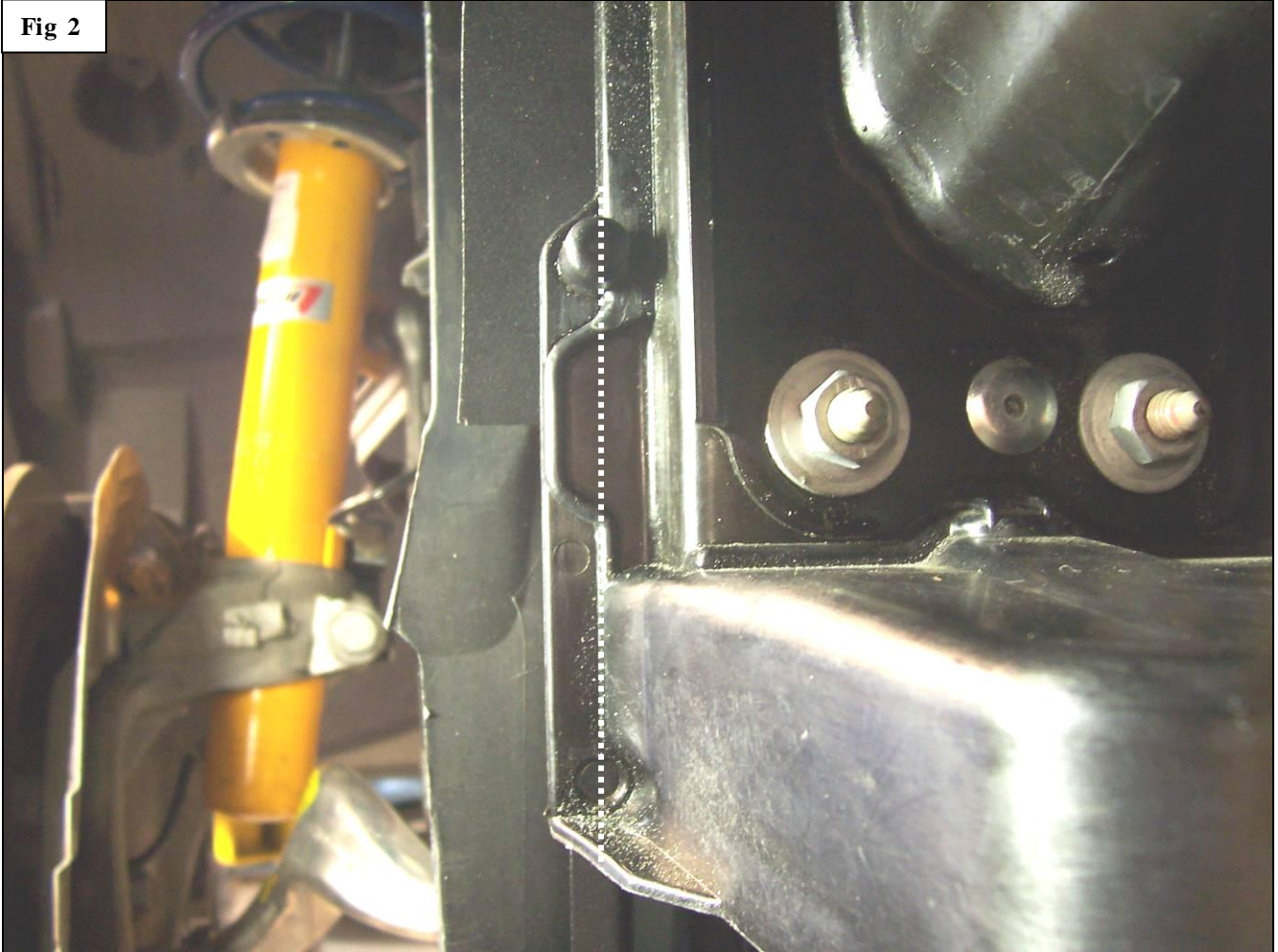

7. Smooth and deburr the cut area where you removed the above edge section. Apply some black touchup paint to any bare metal surface you may have exposed.

Prepare the Right Brake Duct

8. You will carefully mark and trim the right brake duct to fit snugly against the bottom of the Oil Cooler and around the Inner Oil Cooler Hose. This work is a little tedious but when done correctly will leave the right side brake duct flowing well despite the reduction in the outlet area. You will also cut a 7/8" hole in the duct for routing the inner Oil Cooler Hose.

9. Cut off the large mounting bracket from the duct close to duct to make marking the cut-line easier. See photos.

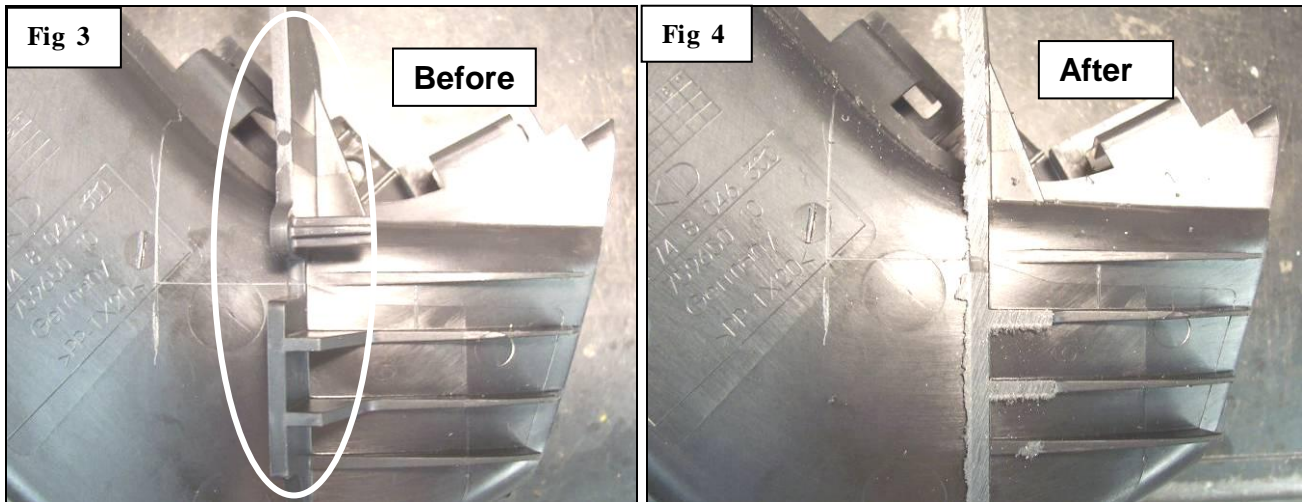

10. Use a small square, a ruler and a sharp scribe to mark the section to be cut on the inner side of the brake duct. Save the silver "captive screw nut" from the piece you cut off. See photo below and next page as well before cutting anything.

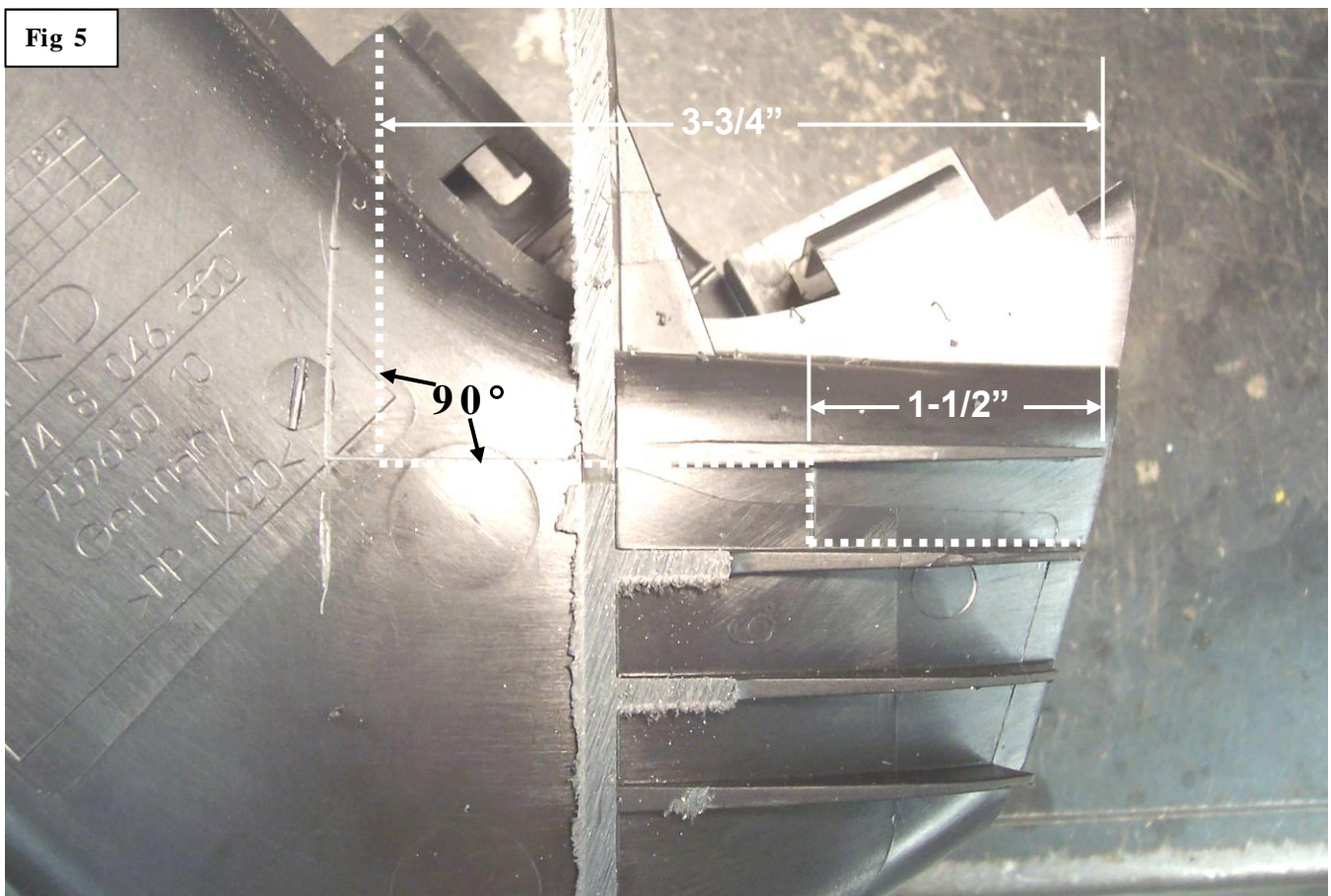

11. Now you can mark the outer side of the right side brake duct. Make the horizontal lines about 1/16" above the "ribs". Note that this duct is already trimmed in the photo.

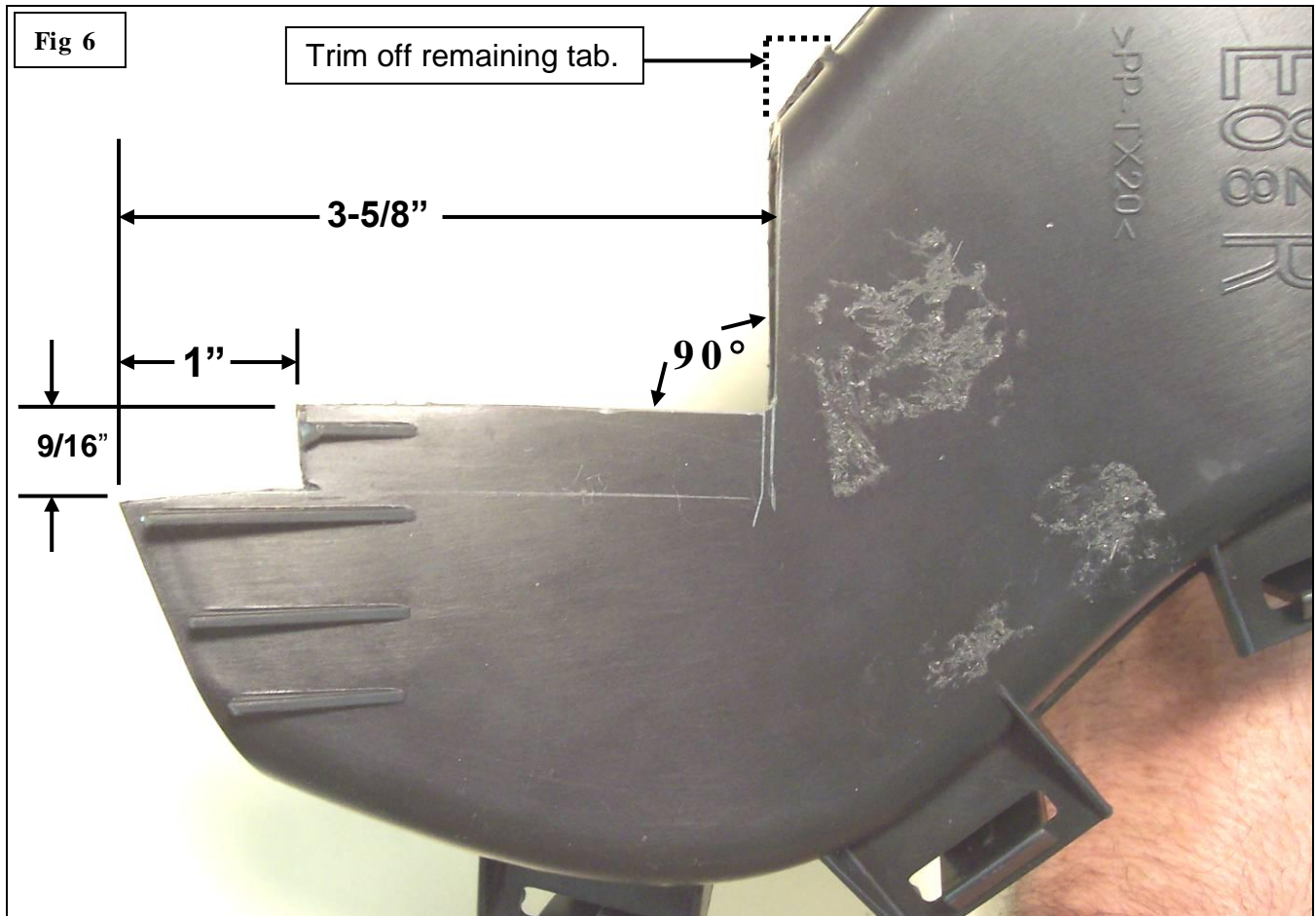

12. Do your best to cut out the section of brake duct that is not needed. You can use a hacksaw to cut the top cut across the duct upper side. Do not cut too much at first - you can easily trim or sand more later.
13. The duct can easily be cut using aviation snips and a hack saw blade. A fiberglass-cutting disc will do a nice job as well. I like to make a "jab saw" using half a hack saw blade with one end held securely in the tip of Vise-Grip pliers. Hold the blade so it cuts on the pull stroke.
14. Measure and mark for the 1-1/8" hole to be drilled in the brake duct as shown in photo below.
15. Use a 1-1/8" hole saw to cut this hole.

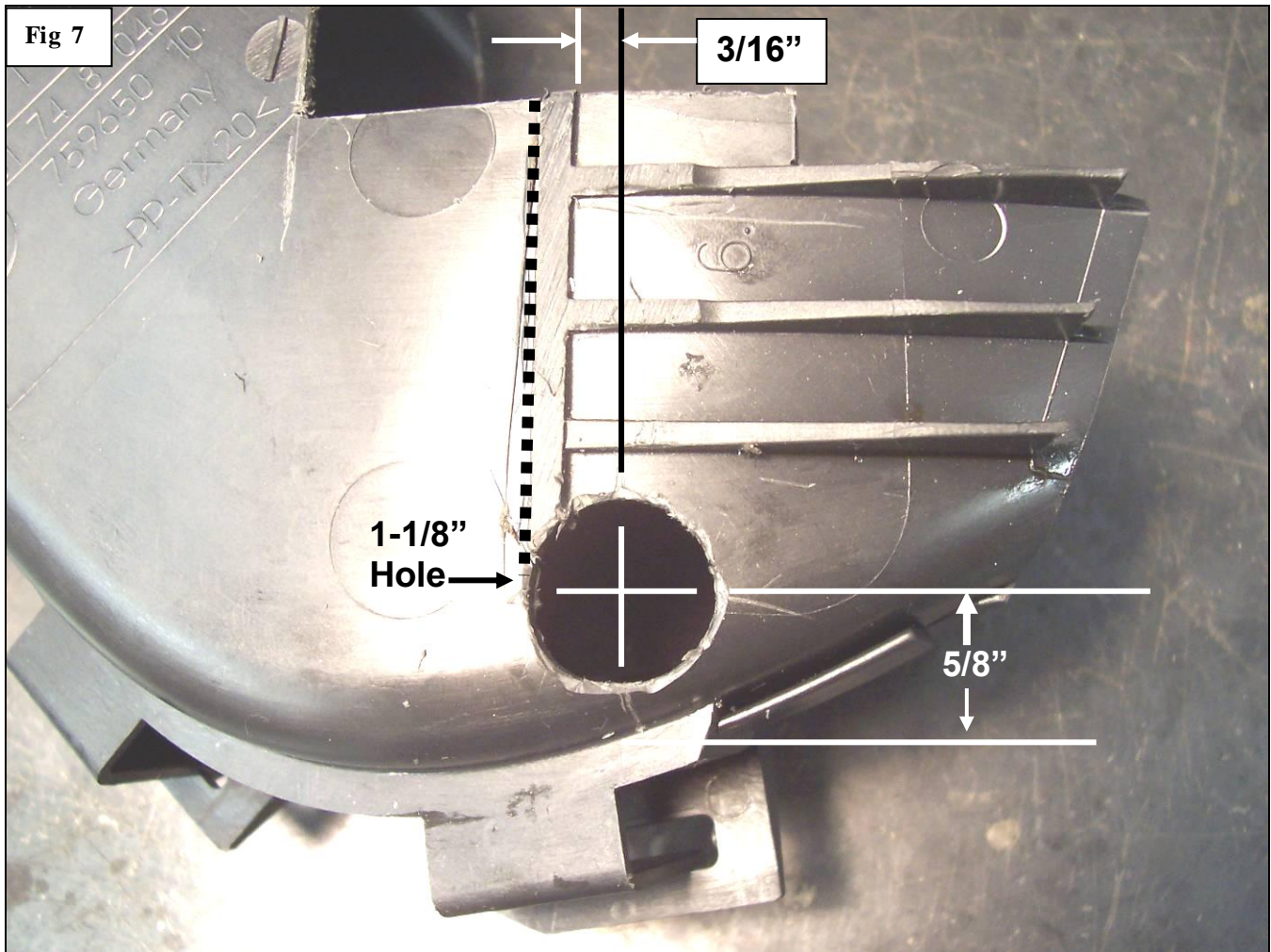

16. Use a die-grinder and a narrow bit to cut a groove in the top of the brake duct as shown below. Make the groove at least $\frac{3}{4}$ " long. This clearancing may not be needed on the later models, check fit before trimming if you want.



17. Do not install the brake duct yet.

18. The **Dinan Oil Cooler** mounts to the two original M8 studs as shown below. Use the stock rubber mounts and metal insert bushings for mounting. Use the two original flange nuts for now. You will need to check the fitment of the brake duct and install it before installing the Oil Hoses, so don't attach these yet.

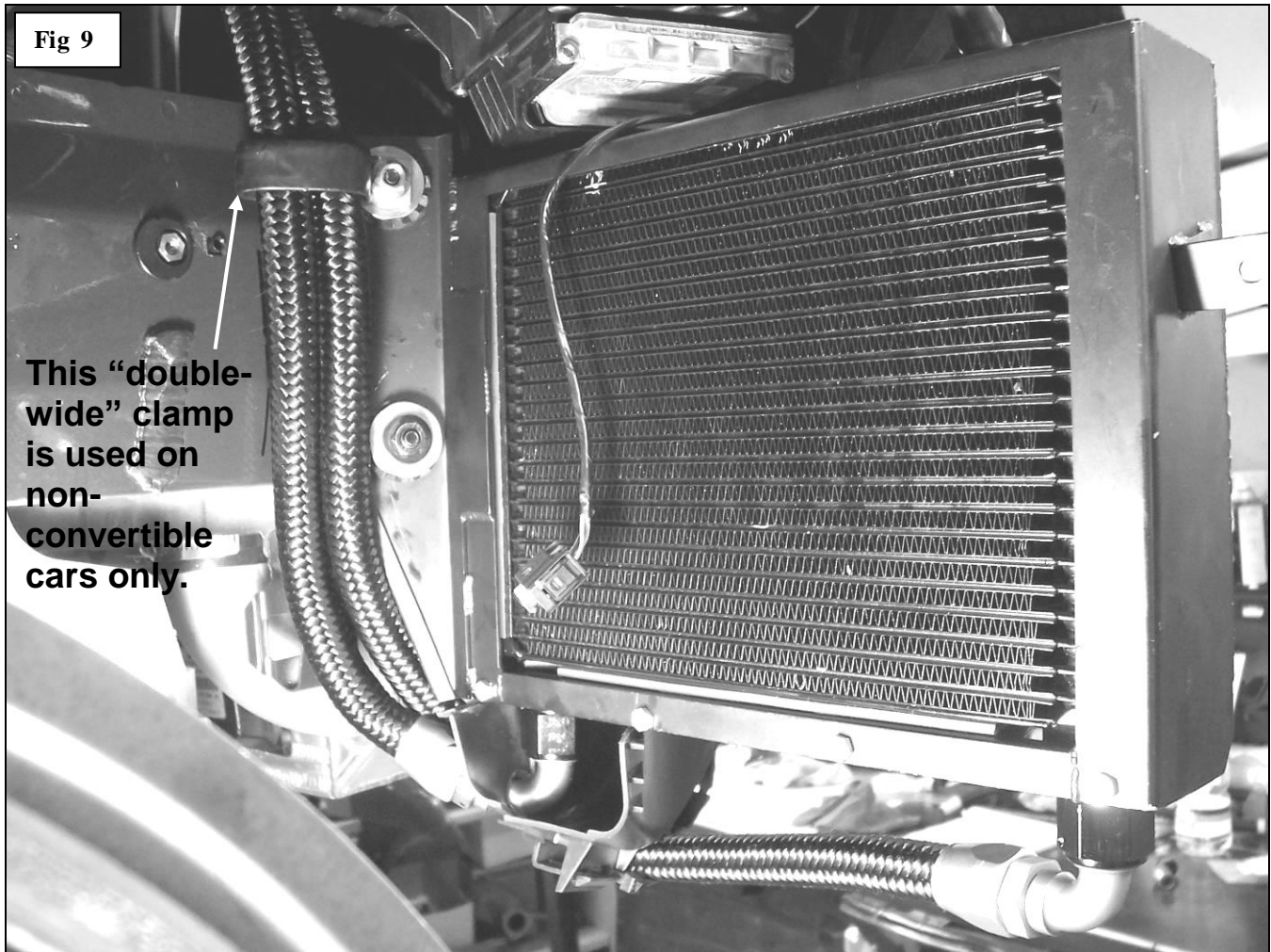

19. Install the brake duct now. See photos below.

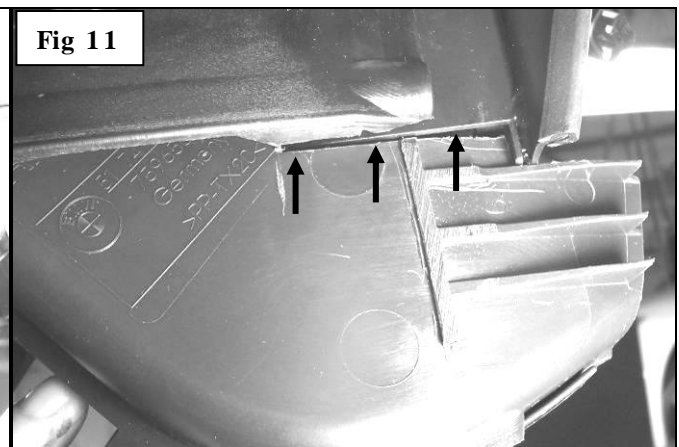
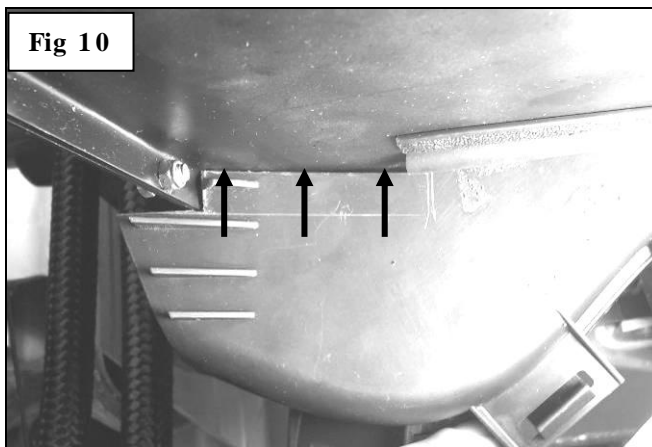

20. Once you have properly fitted the brake duct you can move on to modifying the forward wheel well liner.

Prepare the Right Forward Wheel Well Liner

21. You will need to make a small cutout for Oil Cooler clearance then relocate the RDC receiver (tire pressure monitoring) on the cars with RDC receivers at each wheel.
22. Remove the RDC receiver from the liner.
23. Use the photo to mark then grind out a clearance notch in the floor of the wheel well liner. A larger sized die-grinding bit with fairly fine teeth will give the best results for this operation. This notch will allow a pathway for the Outer Oil Cooler Hose.

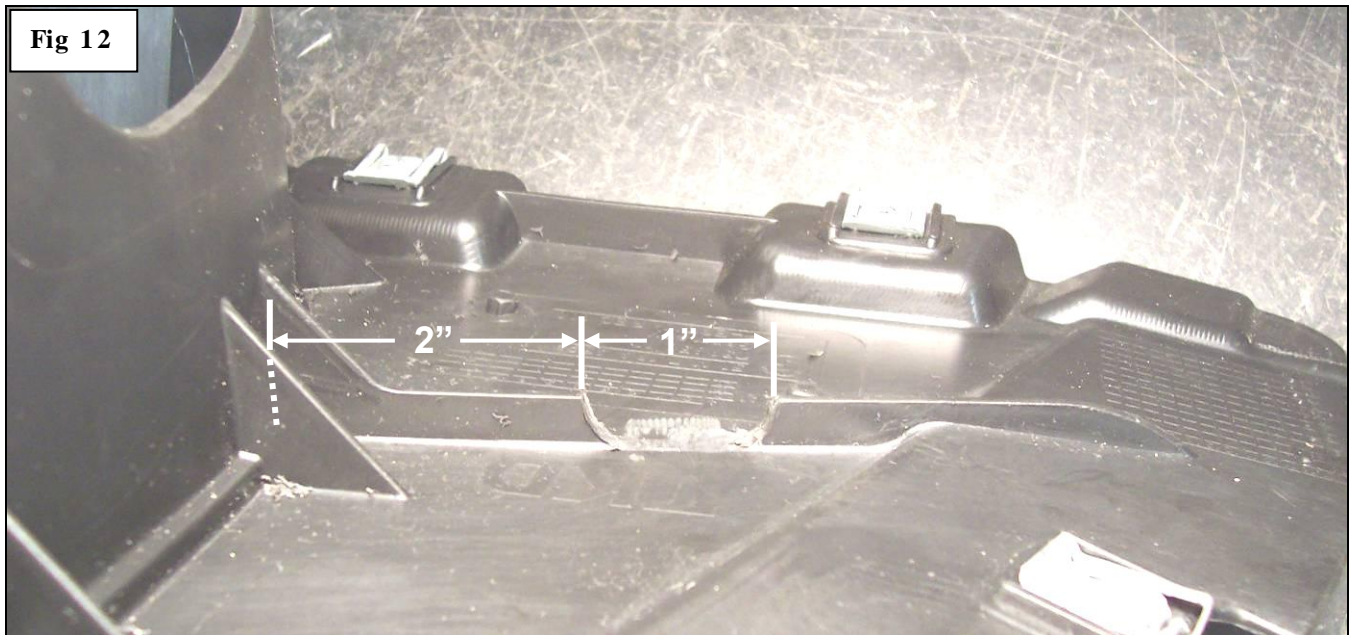

24. Use the photo below to help you measure and mark the small cutout that will allow the wheel well liner to fit around the Oil Cooler.

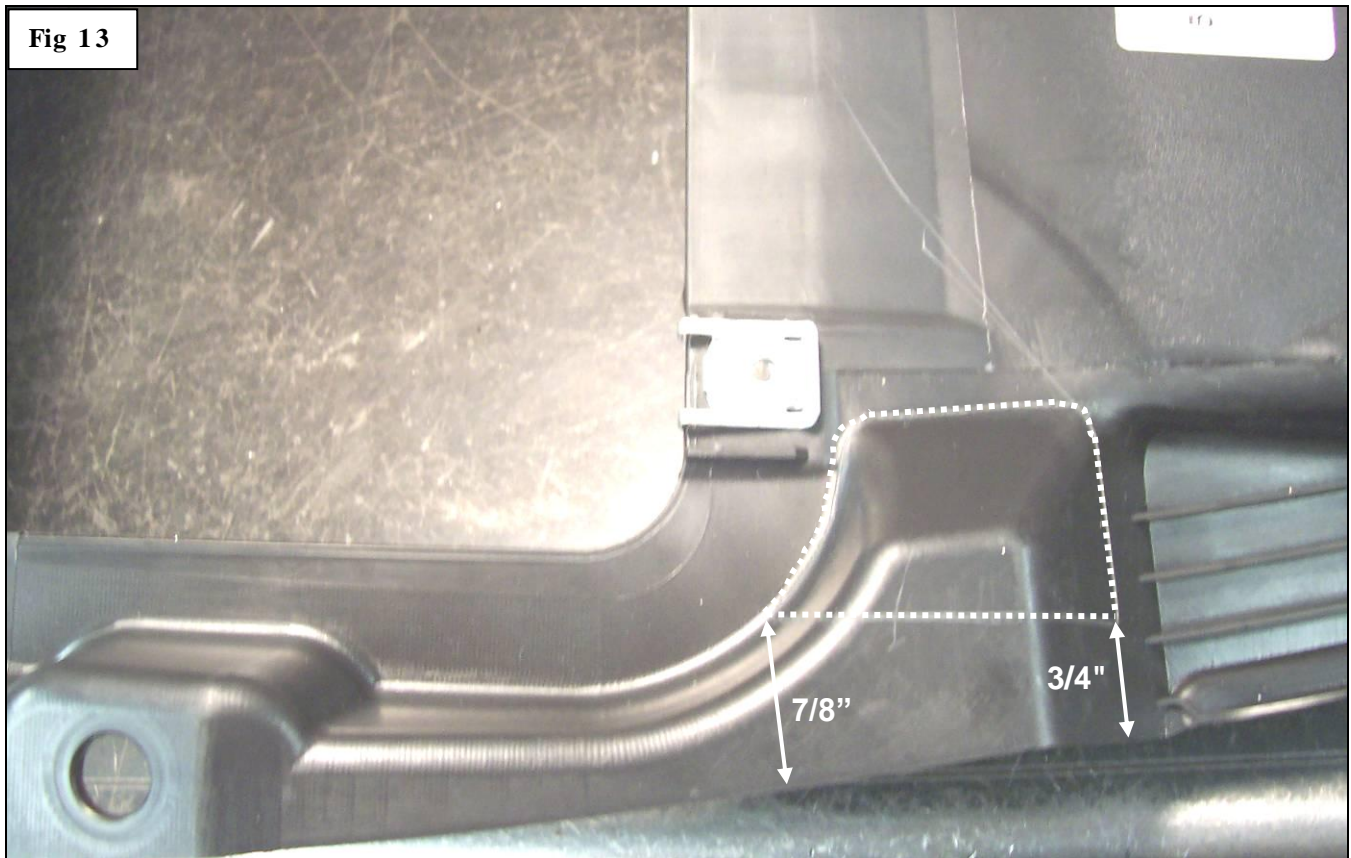

25. A view from the other side after making cutout, see below.

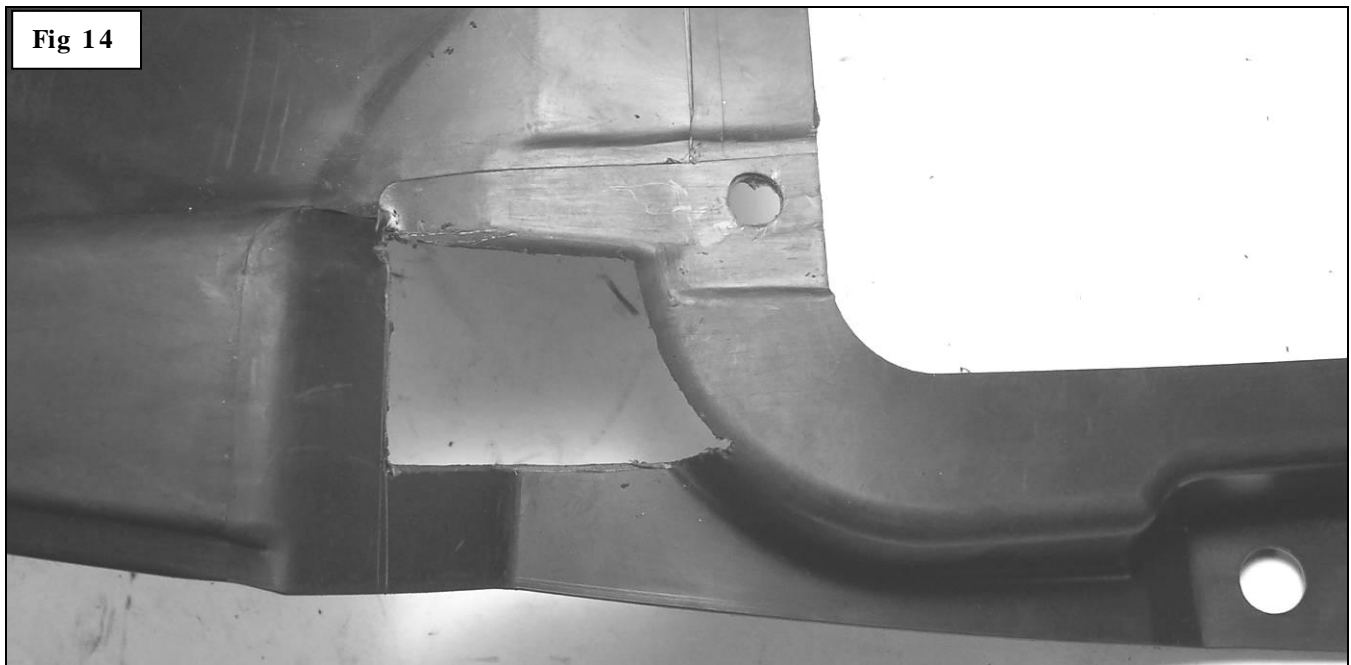

26. You can now relocate the RDC receiver to a higher location on the wheel well liner. Use the photo below to mark a straight line between two points (see circles) then mark and drill two $17/64$ " holes for mounting the RDC receiver. To prevent the $17/64$ " drill bit from "wandering" always use a very small bit to drill a pilot hole first. Start the left side of this line roughly at the middle of the curve in the plastic. Note: the receiver is already mounted in place in the photo.

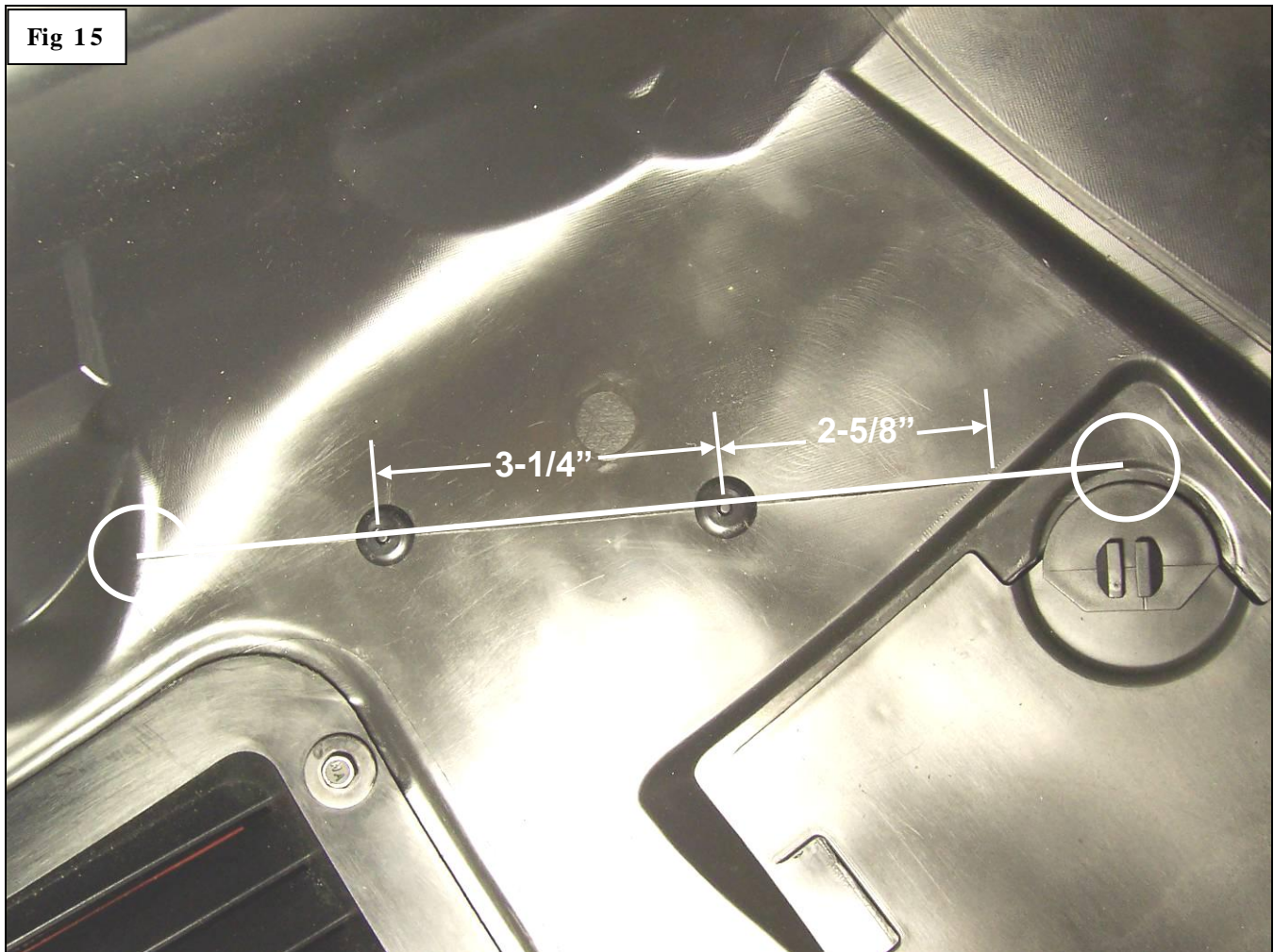

27. Mount the RDC receiver on the front side of the wheelwell liner using the two original rivets with the **connector pointing down**.

28. Use the photo below and a belt sander or similar tool to angle grind the lower outer corner down a bit on the stock outlet louver grill. Notice that the sanded area extends out to the two circles.



29. Deburr the sanded edges.

30. Use the photo below and the captive screw nut you saved from the brake duct trimmings to add another grill mounting screw at the center locations as shown (**see circles**). You will also be removing the lower outer screw (**see square**) and captive nut as this screw would otherwise **wear a hole in the Oil Cooler!**
31. Place the captive nut in between the molded ribs and scribe the center of the two new holes to be drilled in the plastic.
32. Use the scribe to poke a center spot at the two new holes to be drilled in the wheel well liner.
33. Remove the two captive nuts before drilling.
34. Drill two pilot holes, then drill those out to 17/64”.
35. Mount the grill at the four corners then transfer the two new mounting holes onto the back side of the grill.
36. Drill two pilot holes, then drill those out to 17/64”. You should leave the grill off until after the Oil Cooler is fully mounted.

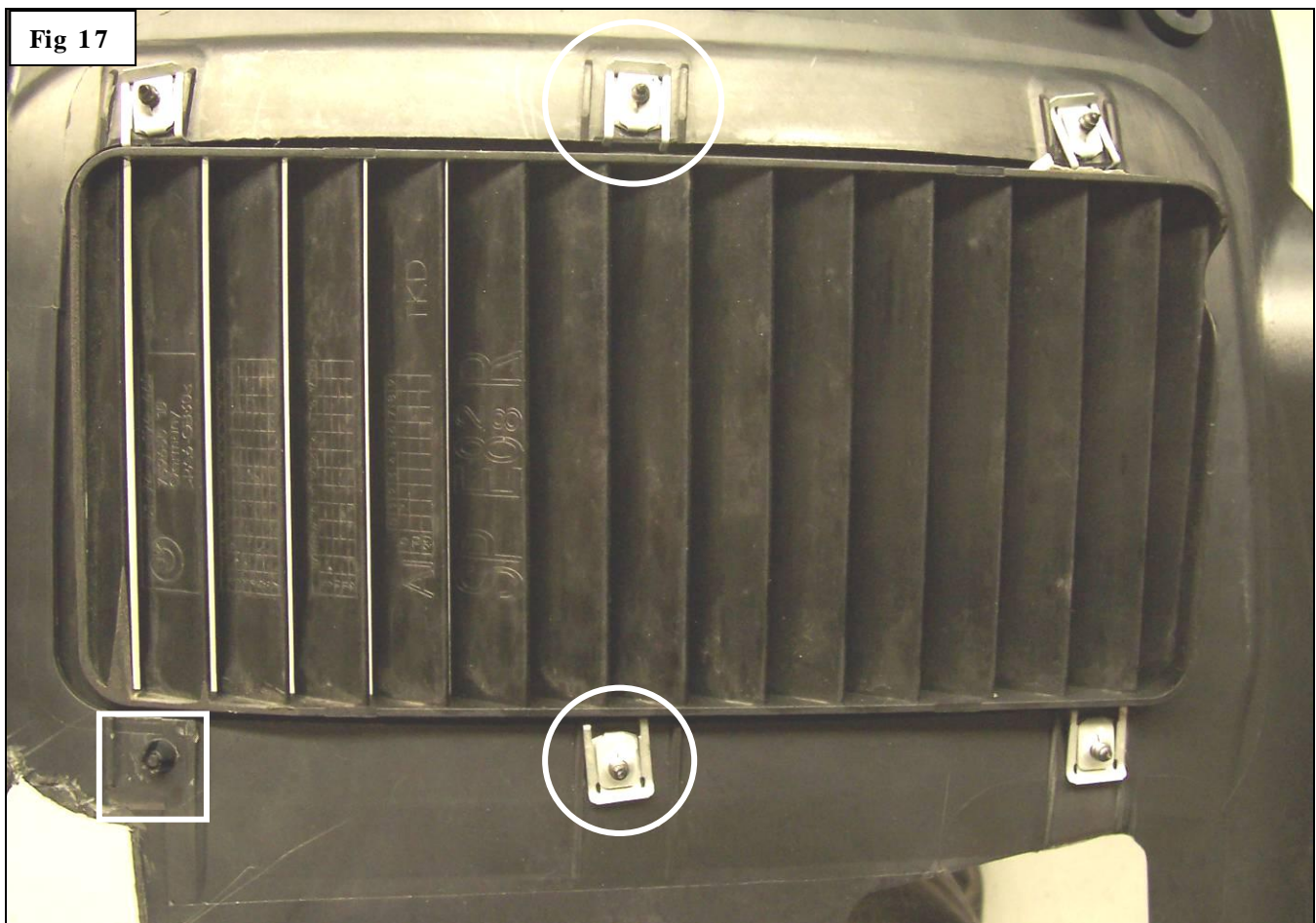

Install the AC Line Support Bracket

37. Replace the AC Line Support Bracket. To make room for the new Oil Cooler Hoses you will need to remove the stock plastic AC line support bracket from the front of engine. This bracket will be replaced by a new steel AC Line Support Bracket that relocates the AC line down and slightly forward. Pull the AC line out of the C-shaped tip of the stock support bkt. Remove bracket and save the single mounting bolt for the new support bracket. See figure 18.

38. Use the photo below to mount the new **AC Line Support Bracket** with the original bolt. Leave the mounting bolt loose enough that the Bracket can be easily rotated if necessary. The free end of this bracket should be just slightly higher than the mounted end or slightly up from level. Use the enclosed **#22 Loop Clamp, M6 x 16 bolt, M6 wave washer** and **M6 nylok nut** to attach the AC Line to the new Support Bracket. The goal is to lower the AC line about 2-1/2" at the swaged collar below the oil thermostat housing. You may want to leave the two bolts slightly loose until the Oil Lines are installed then tighten them when you are sure there is sufficient clearance, as they will still be easy to reach. Be careful to maintain about 1/2" or more clearance between the AC line and the rear of the auxiliary fan assembly at the closest point. You do not want the AC line to hit the fan assembly during hard braking. See figure 19.

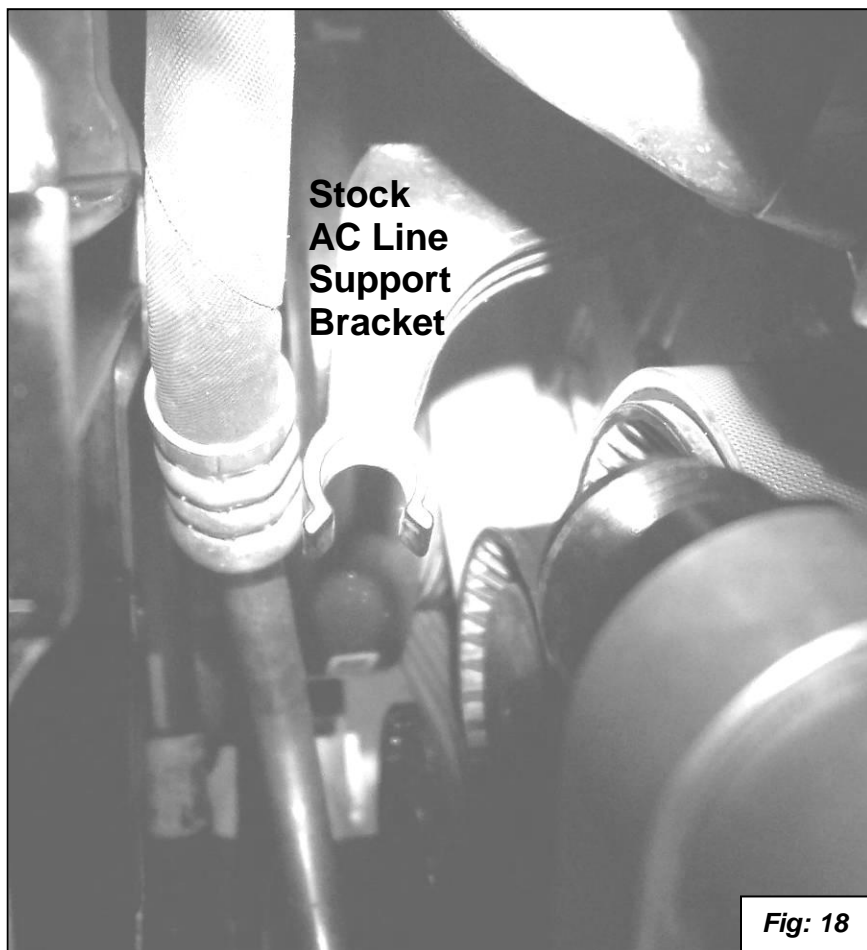

Fig: 18

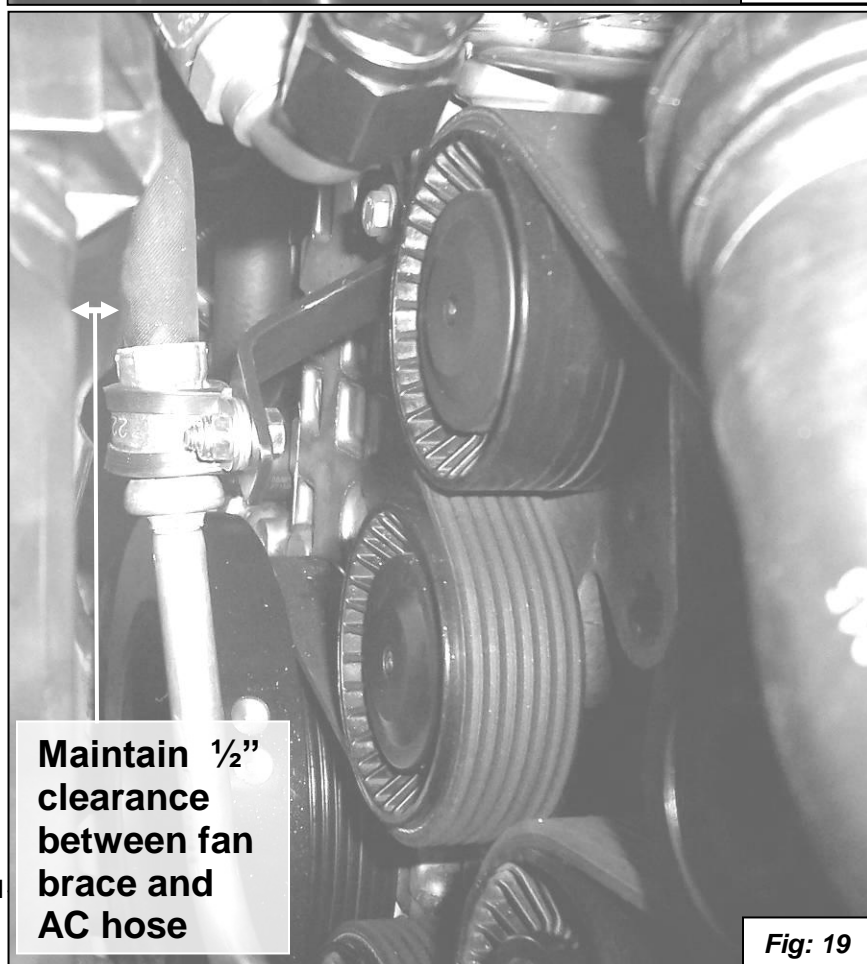

Fig: 19

Install the Oil Line Mount

39. Remove the large dual intake scoop that runs over the top of the radiator to the air filter box (four screws) if it is not already removed.
40. Install the O-Rings onto the **Oil Line Mount** with a little motor oil on the O-rings. Put the 8mm x 25mm Allen head bolt and serrated lock washer in place. Your part will not be welded.



41. Install the Oil Line Mount onto the oil filter thermostat housing. **Double check that the two original O-rings have been removed from the housing!** Make sure the O-Rings don't get pinched as you install the block. Hold the Mount up against the thermostat housing firmly as you tighten the screw. Torque the bolt to 20Nm (15ft-lbs.).

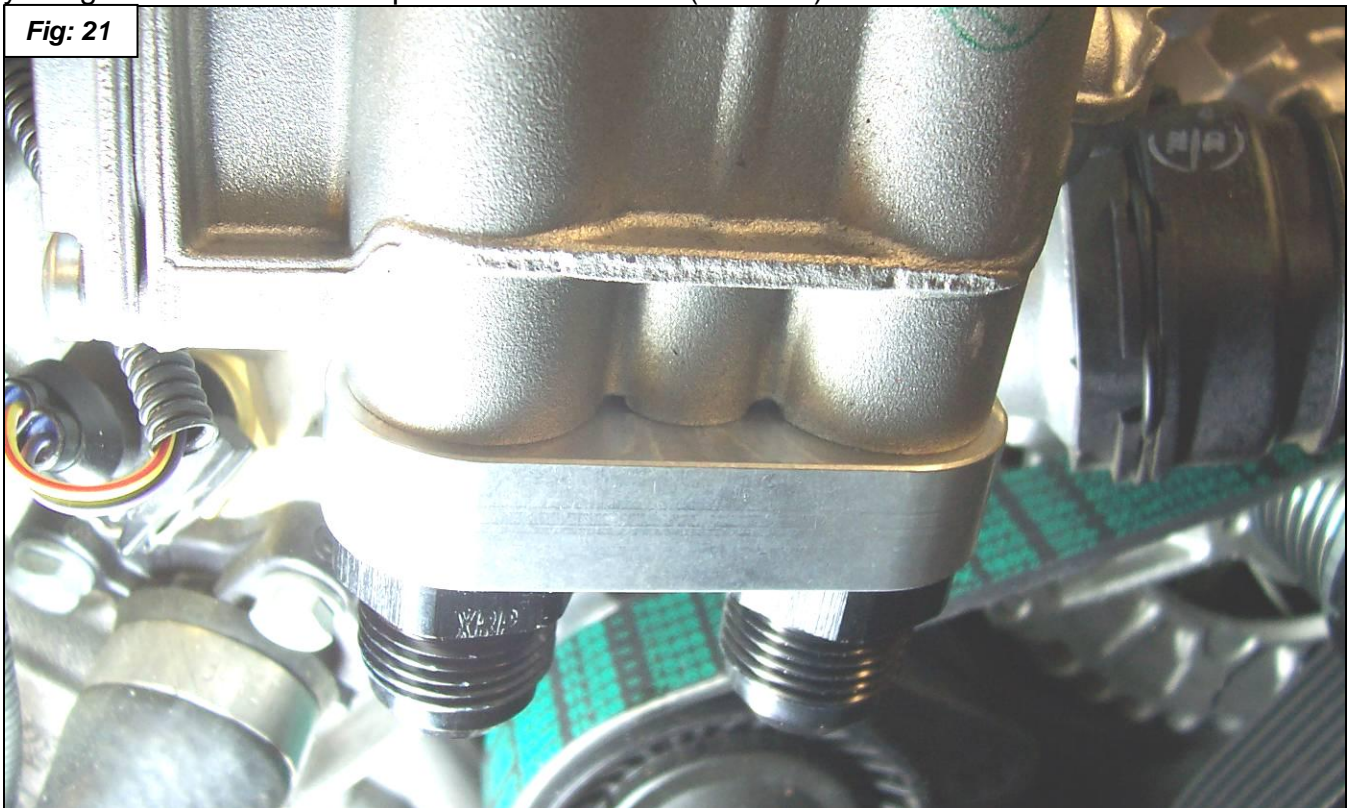

Install The Oil Cooler Hoses

42. You must first install the **Outer Oil Cooler Hose** between the **Oil Line Mount** and the **outer fitting on the Oil Cooler**. I prefer to connect the **“non-swivel” 90° hose end** to the Oil Line Mount first then connect the remaining hose end to the outer fitting on the Cooler. Always apply a little anti-seize compound or engine oil to the threads and mating surfaces of these compression type fittings before assembly to avoid damage to them. Also make it a habit to **always start the fitting threads several turns by hand and only use the wrench to do the final tightening, as these threads are very easy to cross-thread! If they do not turn easily by hand then they are not properly engaged!** Observe the following several photos to familiarize yourself with the routing of the Oil Cooler Hoses before connecting any hoses.

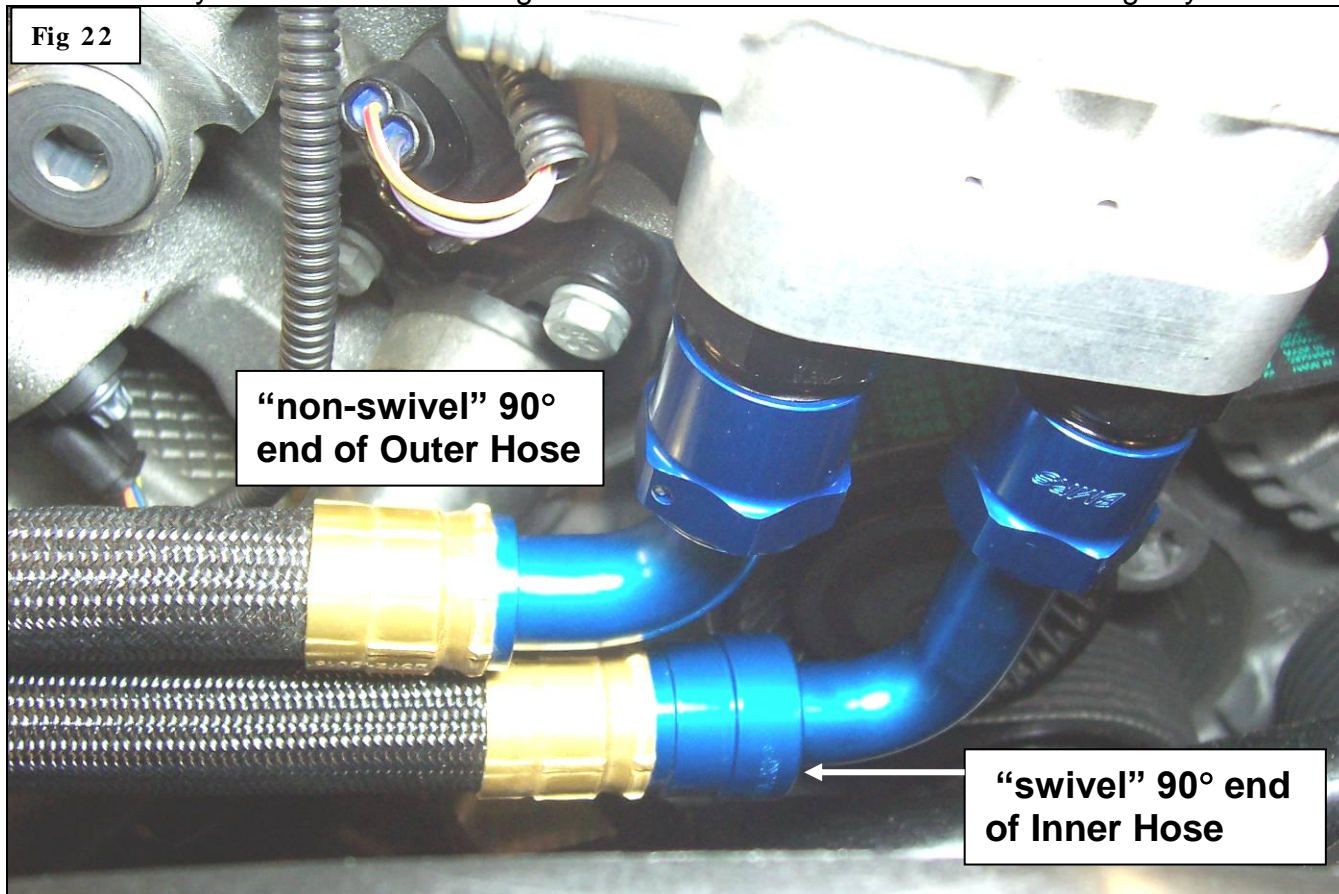

43. Next you will need to connect the **Inner Oil Cooler Hose**. Observe the different photos 21 thru 22 showing the Inner Hose routing. Finger tighten the **120° “non-swivel”** end to the **inner fitting on the Oil Cooler** after applying a little antiseize compound to the threads and sealing surface of the hose end. Note the routing of the Outer Oil Cooler Hose where it goes down next to the Inner Hose (see the white vertical line on **fig 22**). The inner wheel well liner has a vertical corner that will block anything that is rearward of the white vertical line. Next connect the **“swivel” 90° end of Inner Hose** to the Oil Line Mount. Be sure to leave at least 1/4” of clearance between the upper hose end and the AC line you relocated. Tighten the mounting bolts for the AC Line Support Bkt when the hose clearance is correct. **Non-Convertible cars only:** You can install the **“double-wide” loop clamp** now to maintain the proper hose routing.

44. Note: Your hoses/hose ends may appear different than the ones in the photos.

Fig: 23

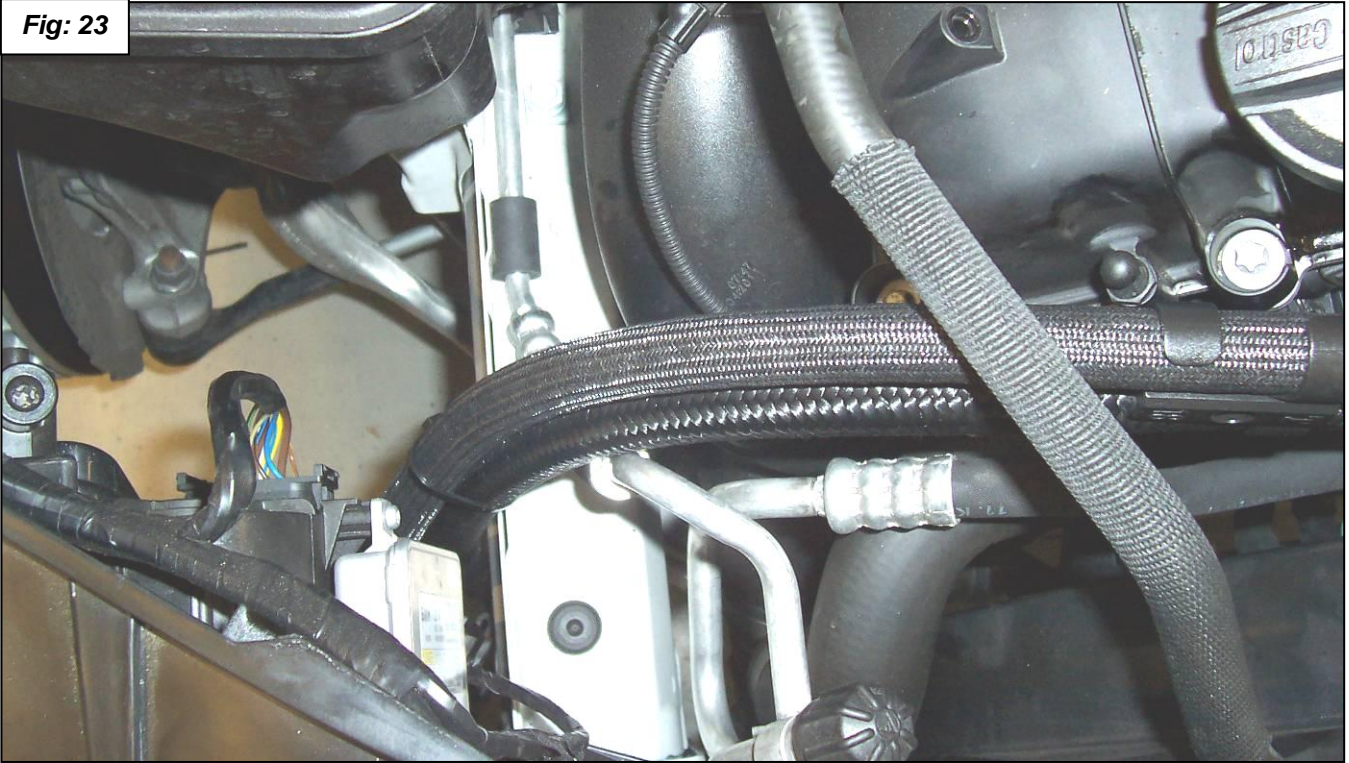
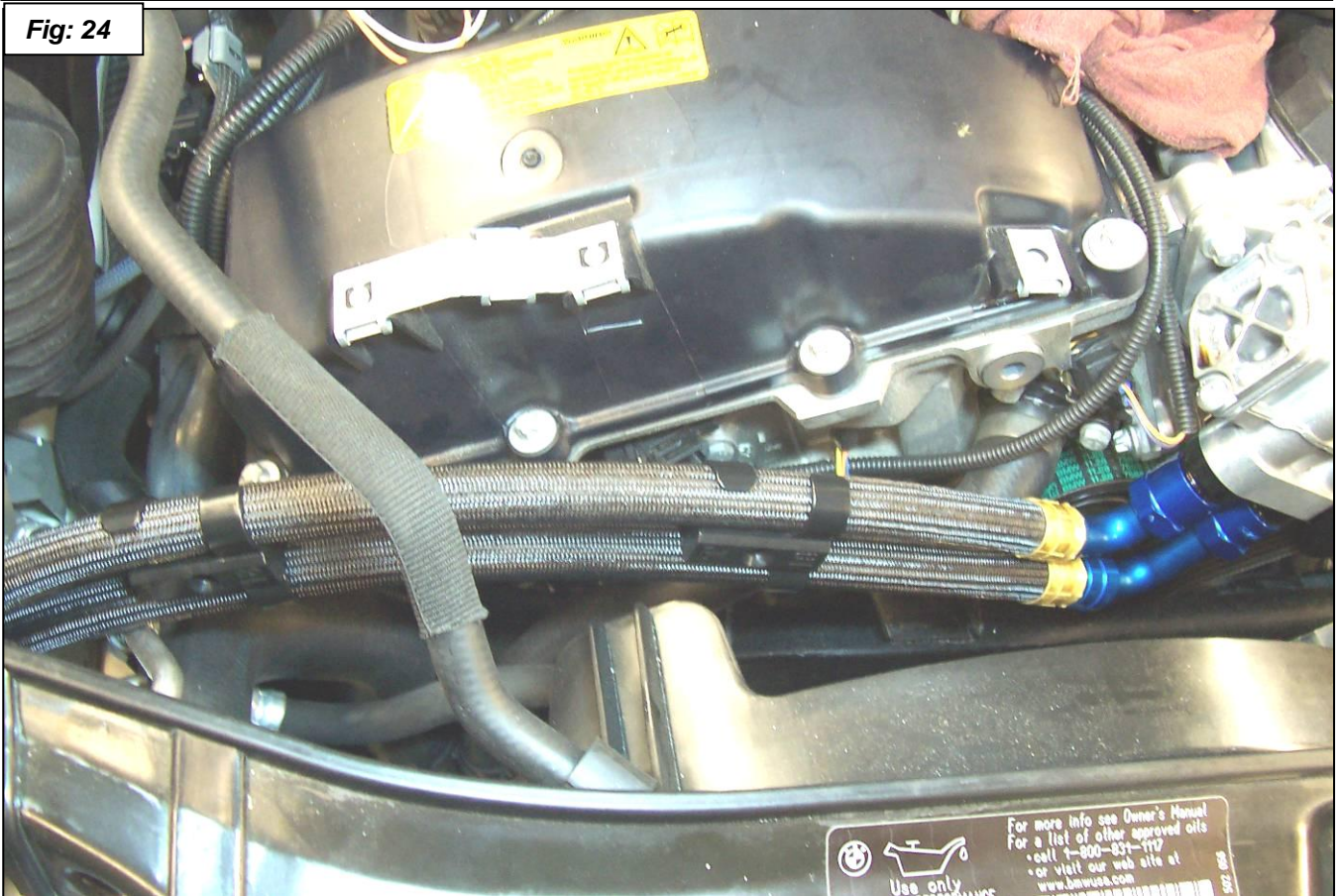
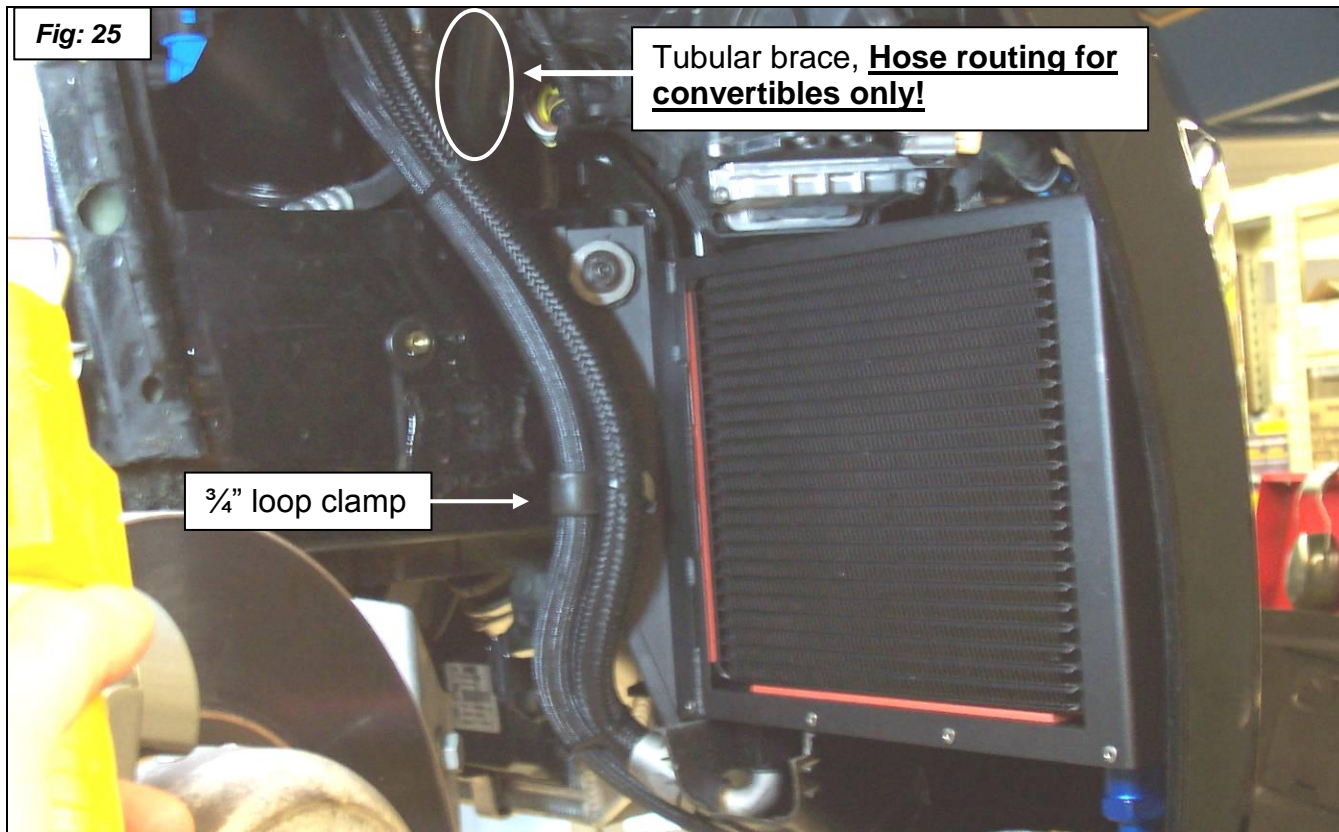

Fig: 24



45. **Convertible cars only:** Do not use the double-wide loop clamp for routing since the hoses will need to go behind the tubular brace as shown below. Use the **3/4" Loop Clamp and M8 locking flange nut** to secure the hose as shown below.



46. Below shows the finished routing of the Hoses on a **non-convertible** car. It is critical that you get the mounted angle of the 120° hose end just right so it **does not kink the hose**, and it will line up with the hole you made in the brake duct. Loosely tighten the 120° hose end so it looks like the lower photo for now. Leave sufficient clearance at the circled bracket.

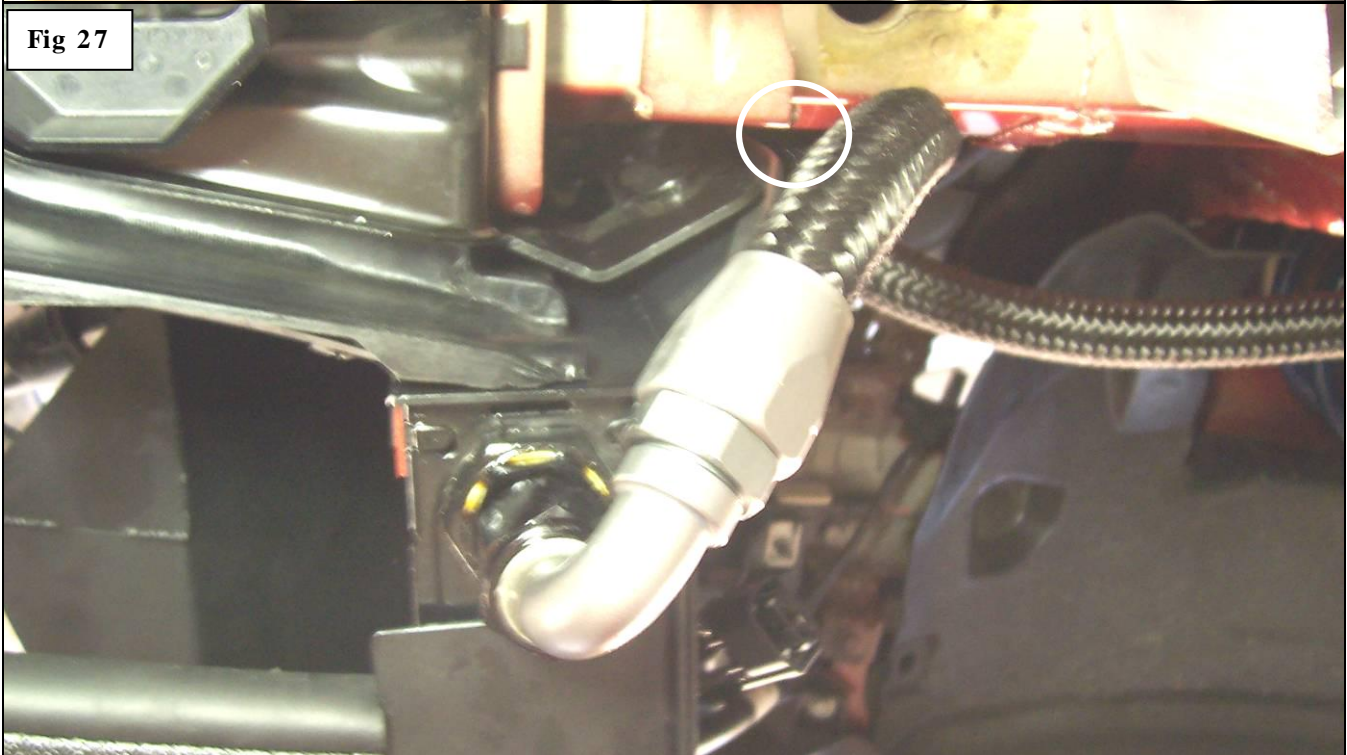
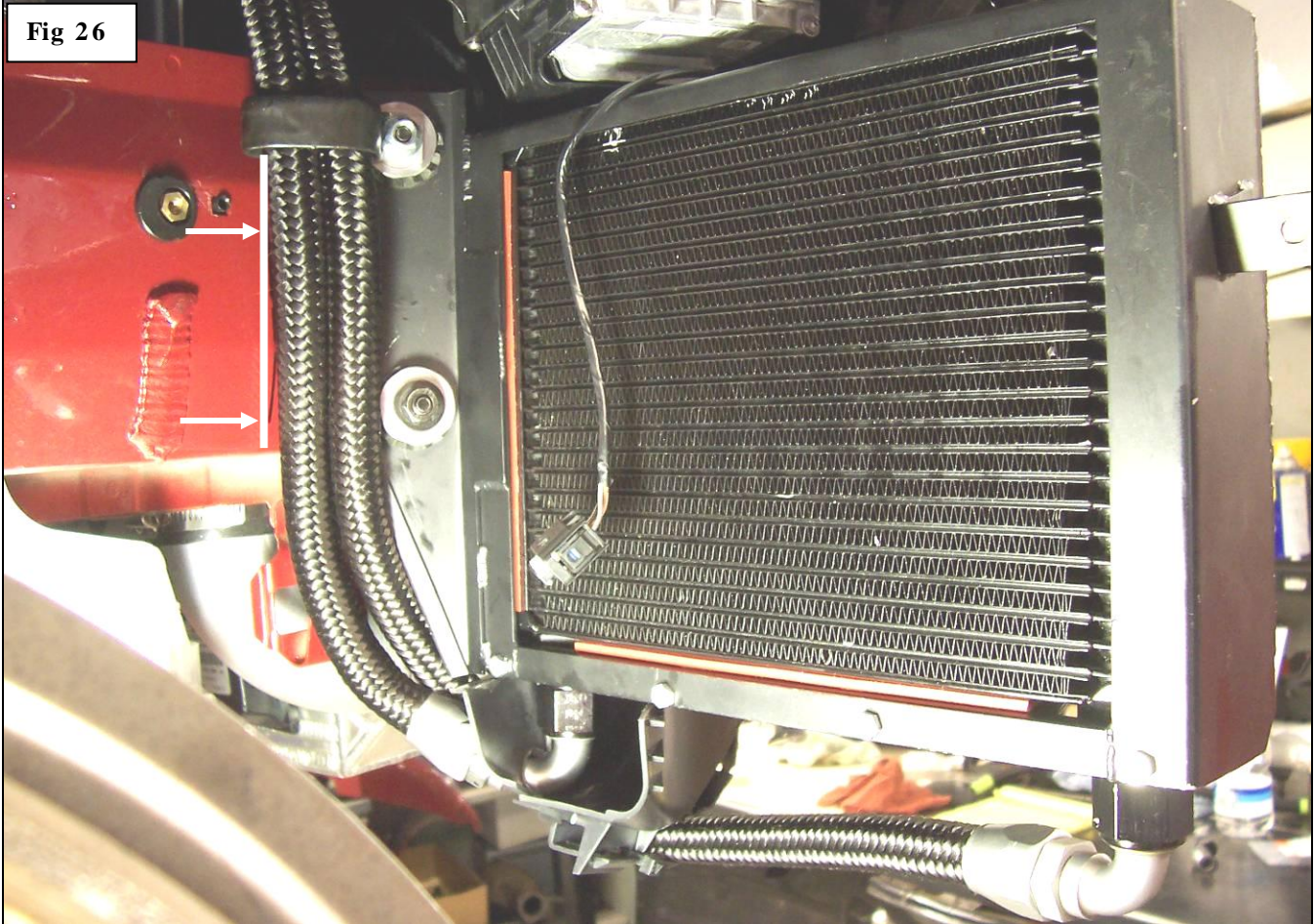

47. You can now mount the modified brake duct. Use the original screw but be careful to not overtighten this screw as you will probably be removing and reinstalling it a few times until you get it right. See the **Figs 28 & 29**.



48. When you are satisfied with the fit and routing of the Inner Hose go ahead and **tighten the hose ends**. Note the Hose routing in the previous photos. **Be sure to use a wrench to hold the compression fitting on the Oil Cooler while you tighten the hose end. Be careful to not loosen the screw-in fittings at the Cooler and Oil Line Mount!** Leave a 5/8" to 3/4" gap between the Cooler Hose and the vertical rib on the radiator fan frame.

49. Before you tighten the hose end at the outer fitting of the Cooler you will need to attach the Outer Hose to the notch in the brake duct as shown using a wire tie. This routing is critical as the wheel well liner is very tight against the brake duct. See below.



50. By now you should have the Oil Cooler Hoses in place and all hose ends tight. If not, tighten them now.

51. Use two **Pairing Clamps** to secure the Oil Hoses together as shown in **Fig 24**. The Hoses should be secured in a manner that does not let them rub on anything.

52. Add 1/2 to 1 quart of engine oil depending on where the oil level was initially.

53. I prefer to start the car and run it for several minutes so I can check for even the tiniest oil leak. Start the engine and run it at about 2,000 RPM's for a few minutes or until the oil thermostat opens if you have the time (preferred). Closely look over the hose ends and Oil Line Mount for possible leaks. Retighten as needed.

54. You can now reinstall the front “bumper skin” and the wheel well liners while connecting the RDC receiver wires. **Make sure that the small outer mounting tab for the Oil Cooler will line up with the appropriate captive screw nut in the bumper skin before installing the right side wheel well liner.** Take your time to carefully position the right side wheel well liner around the Oil Cooler, and again **be sure that the Oil Cooler outer mounting tab gets properly screwed down. Reach in and lift the Cooler to line the holes up if necessary.**
55. Install the oil cooler outlet air louver grill. Use the plastic rivet from the hardware kit to mount the lower right side corner of the grill.
56. Reinstall the large plastic lower engine cover.
57. Reinstall the wheels and torque them.
58. Congratulations you have completed the installation of the Dinan Oil Cooler!