

PLEASE  
READ BEFORE  
STARTING  
INSTALLATION!

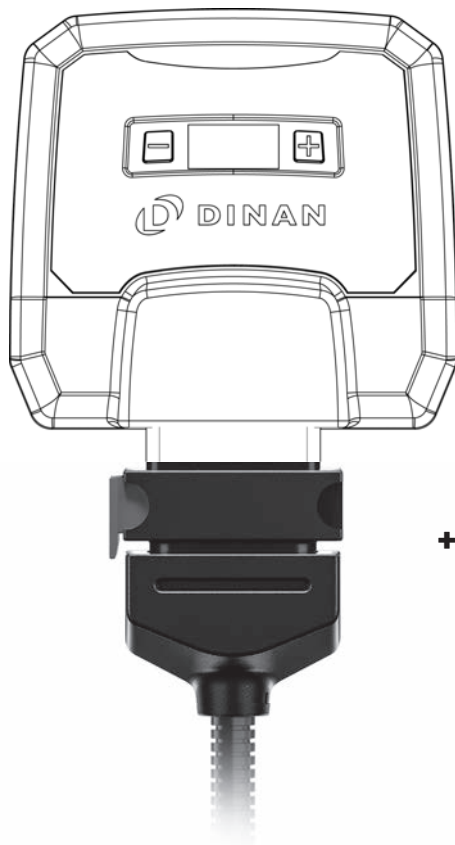

+  **APP-CONTROL**

# *User Manual*

## *Performance upgrade*

D440-0146: DINANTRONICS X; S63 B



# Contents

1 Scope of Delivery .....	A
2 Overview of the performance upgrade .....	B
3 Installation .....	C
4 Fine tuning .....	D
5 Trouble Shooting.....	E

## Overview and explanation of symbols



**Warnings** and important information – **please read!**



**General information** on installation and use



**Tips** to assist installation and use

# 1 Scope of Delivery

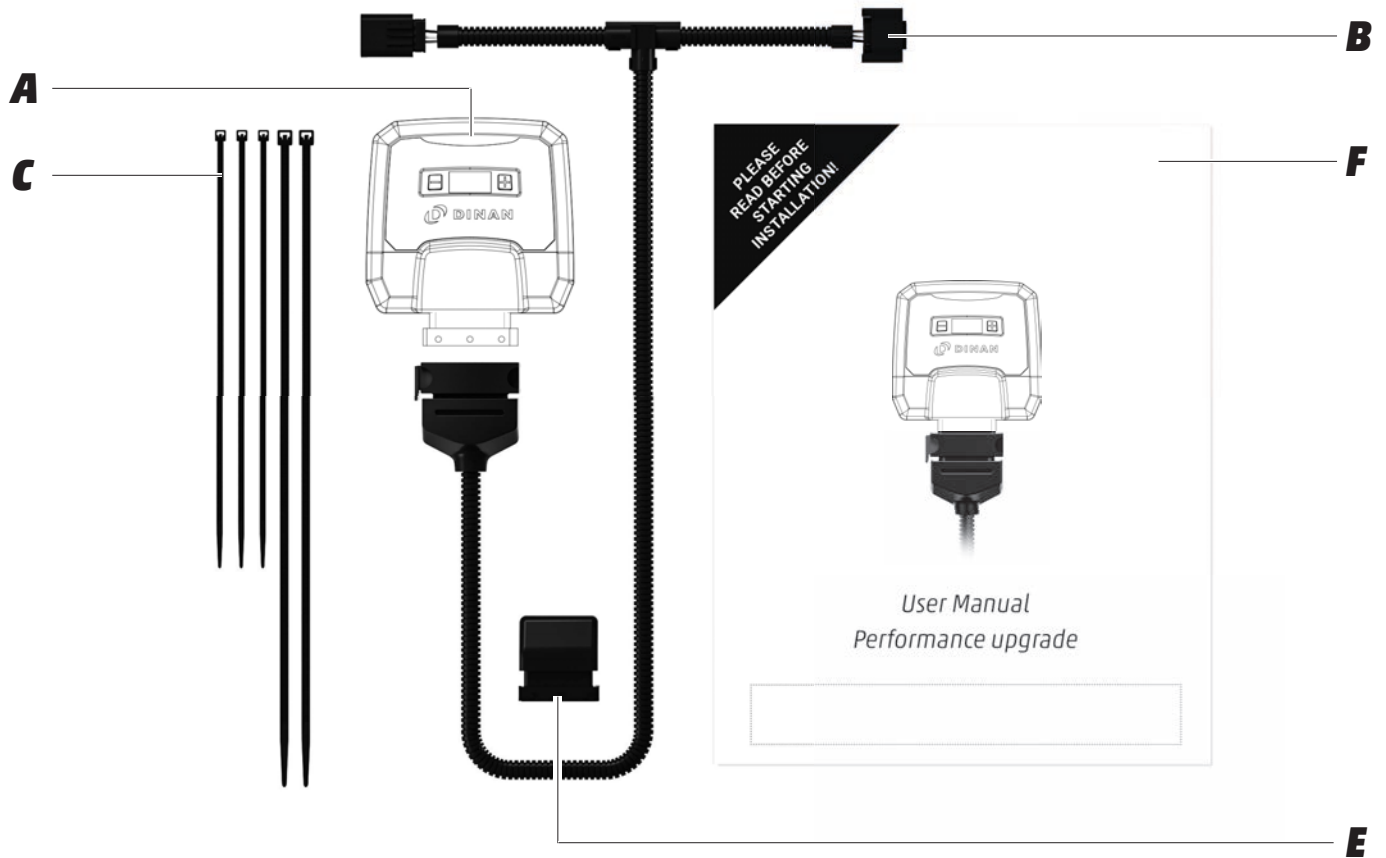

**A** **Performance upgrade**  
calibrated specifically for your vehicle

**B** **Wiring harness**  
automobile-grade, compatible with your vehicle <sup>(1)</sup>

**C** **Cable ties**  
to mount the Performance upgrade and the wiring harness  
2 x long cable ties  
3 x short cable ties

**E** **Deactivation plug**  
returns your engine to stock tune

**F** **User Manual**  
installation and operation

<sup>(1)</sup> Picture may differ from delivered product.

## 2 Overview of the performance upgrade

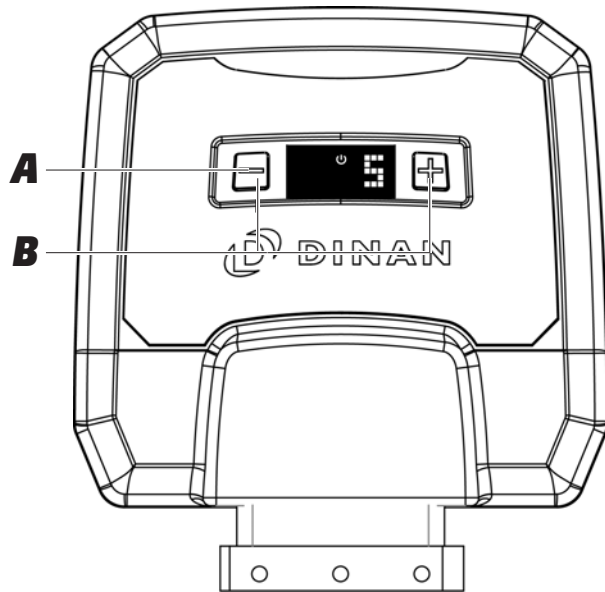

**A** Digital User Interface for controlling the performance upgrade.

**B** +/- buttons for changing the mapping (see *Fine tuning*)

**C** Power ON light; lights only when the vehicle ignition is on and power is being supplied to the performance upgrade.

**D** Display showing mapping selected (see *Fine tuning*).

**E** Slots for cable ties to mount the product

**F** FCI plug for connecting to the vehicle's wiring.

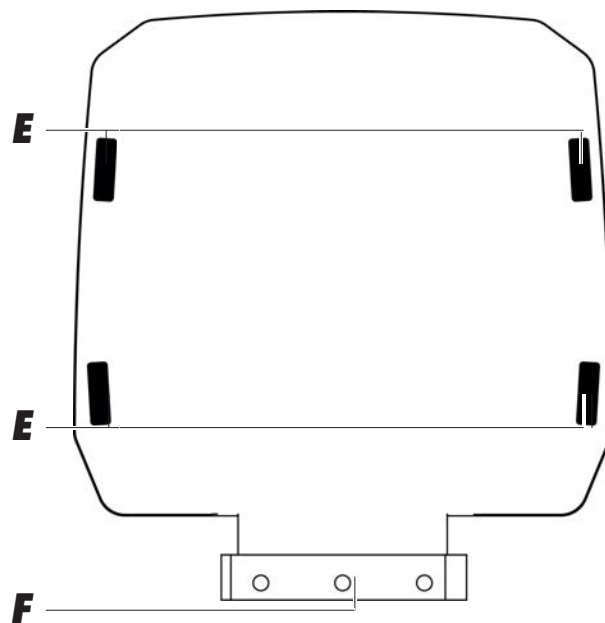

# 3 Installation

## Step 1 - Preparation

**⚠ WARNING** Before installing the tuning module, please wait for your engine to cool down. Otherwise there is a risk of sustaining burns.



Put on the parking brake (emergency brake) before starting installation.



If an **alarm system** is fitted: disable the alarm before starting installation. For further instructions, check the manual of the car manufacturer.



Some cars **will not lock completely** if the hood is open and electrical consumers are still active. If this is the case with your car, push the hood catch over manually, lock the car again and wait ca. 15 minutes. When you have finished the installation, do not forget to release the catch again by pulling the hood release lever.



Turn the ignition off and lock your vehicle. For cars with "**Keyless Go**": after locking the car, place the key out of signal range (about 11 yards or 10 meters from the car).



After locking the vehicle, **wait about 10 minutes** before starting **Step 2**, as all current consumers must have switched themselves off.



Generally speaking, you do not require special tools to perform the installation. If you need a tool, we will tell you when you get to the relevant step in these instructions. You will probably find wire cutters useful for clipping off the loose ends of cable ties.



- If you have any questions or difficulties during the installation, please refer to **Trouble Shooting** for hints and tips.

# 3 Installation

**NOTICE** If you do not wait for at least 10 minutes, electrical voltage and signal flow may still be present in the connections. Detaching the connectors while electronic signals still flow, may damage your vehicle.

**NOTICE** Never turn on the ignition while connectors are disconnected. Risk of check light on the dashboard!

**NOTICE** Disconnecting the battery may damage your vehicle. Do not disconnect the battery at any time, if not otherwise prompted in the instruction manual.

**NOTICE** If stock parts must be dismantled, please check vehicle manufacturer manual for tightening torques.

**NOTICE** To avoid damages at electronic vehicle components, you have to be sure that you have done all necessary methods for electrostatic discharge.

**NOTICE** Tuning modules are developed, produced and tested for vehicles in stock condition.

**NOTICE** Using 3rd-party on-board diagnostic (OBD) scan tools may damage your vehicle. Do not use them.

# 3 Installation

## Step 2 - Removing the engine cover

- Remove the engine cover and place it next to the car.



Generally speaking, you do not require special tools to perform the installation. If you need a tool, we will tell you when you get to the relevant step in these instructions. You will probably find wire cutters useful for clipping off the loose ends of cable ties.

**NOTICE** Using wrong tools or too much force may damage parts of your vehicle. Use appropriate tools. Do not use too much force.

# 3 Installation

## Step 3 - Connector locations



View of longitudinally mounted engine

**(A) turbo boost pressure sensor**

**(B) turbo boost pressure sensor**



# 3 Installation

## Step 4 - Connection to turbo boost pressure sensor



- To begin, locate the turbo boost pressure sensor in your engine bay.

### Setup illustration

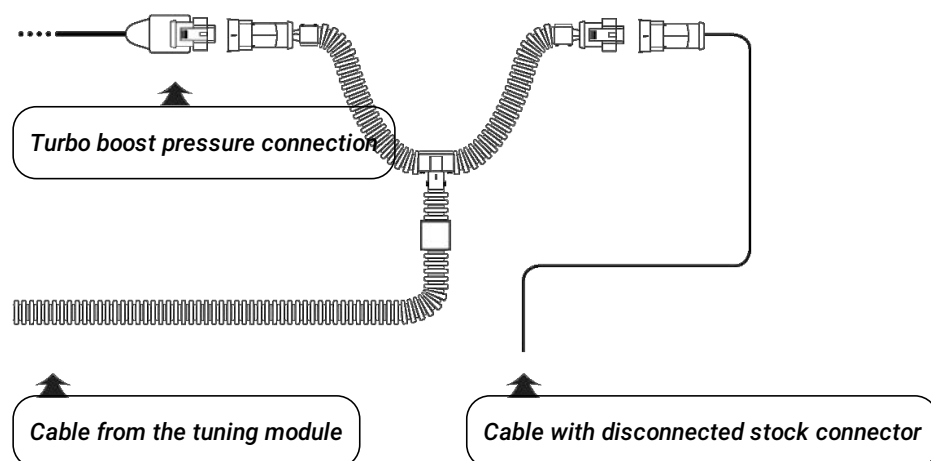

## 3 Installation

- Disconnect the plug from turbo boost pressure sensor.



If you experience difficulties disconnecting the turbo boost pressure sensor, see **Detaching the Connector Correctly** (separate document) for assistance.

- Now connect the end of the wiring harness marked "**A**" to the disconnected connector and the other end to the sensor.



**Make sure that the plug's locking clip engages again. You should hear a sharp CLICK.**

# 3 Installation

## Step 5 - Connection to turbo boost pressure sensor



- To begin, locate the turbo boost pressure sensor in your engine bay.

### Setup illustration

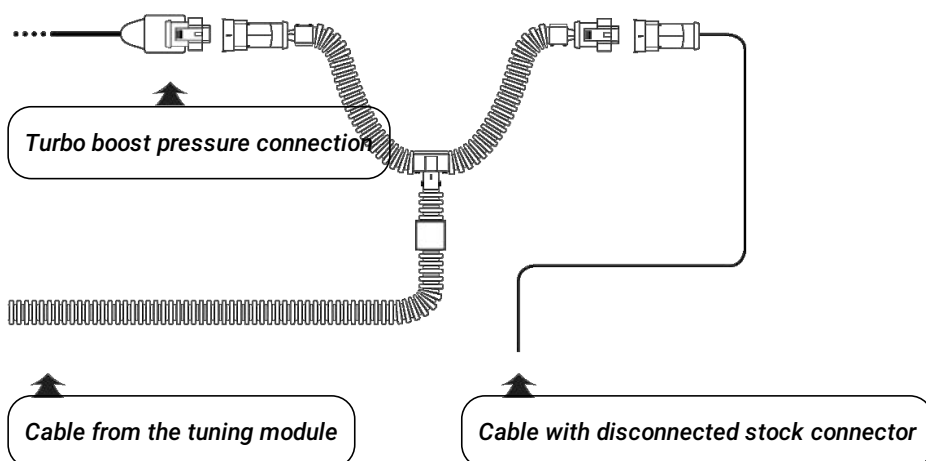

## 3 Installation

- Disconnect the plug from turbo boost pressure sensor.



If you experience difficulties disconnecting the turbo boost pressure sensor, see **Detaching the Connector Correctly** (separate document) for assistance.

- Now connect the end of the wiring harness marked "**B**" to the disconnected connector and the other end to the sensor.



**Make sure that the plug's locking clip engages again. You should hear a sharp CLICK.**

# 3 Installation

## Step 6 - Connecting and first function test

- 1** Disconnect the deactivation plug from the wiring harness



- 2** Connecting to the wiring harness



**i**

- If the Digital User Interface lit up as soon as it was connected, this means that there was still power in the system during the installation.
- In some cases, this can lead to an error message during the first function test. Please refer to **Trouble Shooting** for a solution.

- 3** Carrying out function test

- Position the tuning module and the wiring harness safely in the engine bay.
- Switch the ignition on. **DO NOT** start the engine.
- Check for the following:
  - Control lights on the dashboard light up and go out as normal
  - The Power ON light on the Digital User Interface of your tuning module lights up (see **Overview**)
- If all the above happens, you can start the engine. It should start as normal and should react to the throttle when idling.
- Switch off the engine and ignition.

**i**

- If your car will not start as normal, please refer to **Trouble Shooting** for hints and tips

# 3 Installation

## Step 7 - Fixing the tuning module and wiring harness

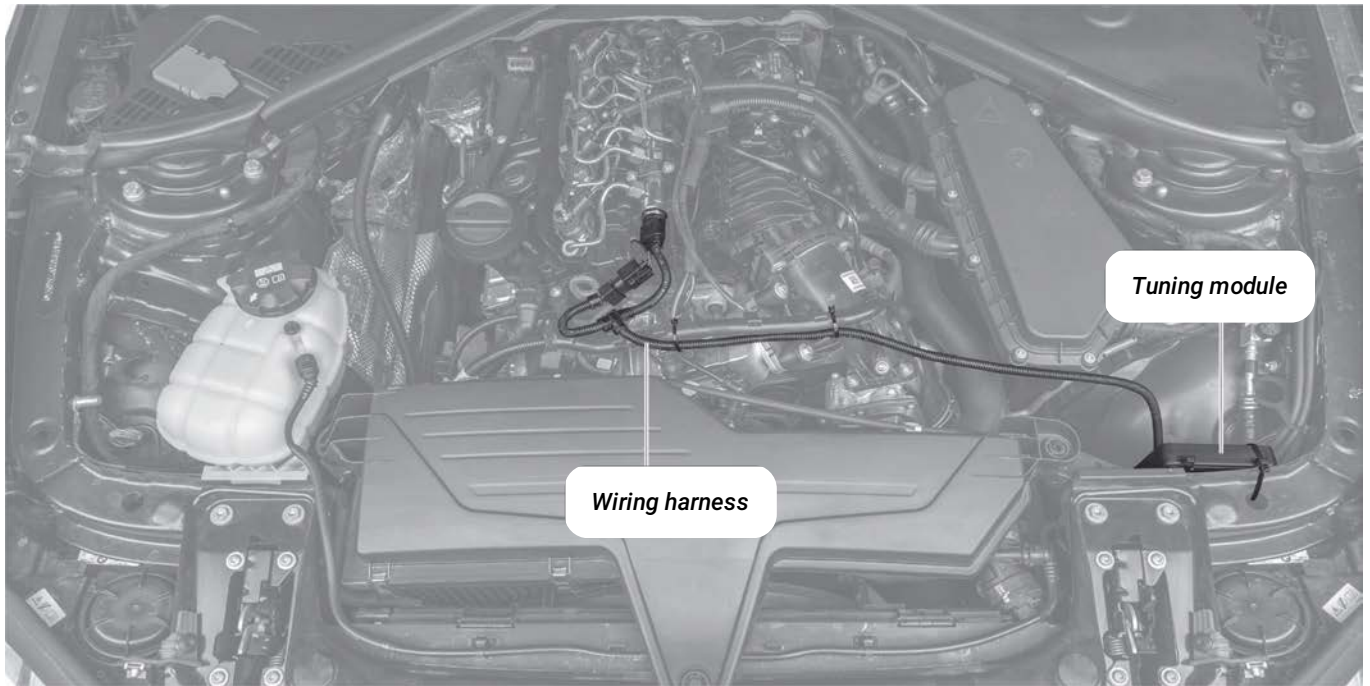

- Before fixing the tuning module in place in the engine bay, ensure that the wiring harness can also be routed and fixed securely without putting it under excessive tension.
- Route the cable along a suitable path (for example, along existing wiring harness) and then fasten it using the supplied cable ties.



- When selecting a fastening point, make sure that the tuning module is protected from exposure to water, heat, and vibrations.
- Do not wrap the tuning module in an airtight bag as this can lead to a built up of condensation.
- Do not route the cable in areas in your vehicle that become overly hot during operation (e.g. the exhaust system, turbocharger, etc.).
- Do not route the cable along movable parts.
- Never fasten the cable onto hoses (e.g. a brake hose) as this could result in abrasion.



- When selecting a fastening point, make sure that the tuning module is protected from exposure to water, heat, and vibrations.
- Do not wrap the tuning module in an airtight bag as this can lead to a built up of condensation.
- Do not route the cable in areas in your vehicle that become overly hot during operation (e.g. the exhaust system, turbocharger, etc.).
- Do not route the cable along movable parts.
- Never fasten the cable onto hoses (e.g. a brake hose) as this could result in abrasion.

# **3 Installation**

## **Step 8 - Completing the installation**

- Re-attach the cover of your engine and close the bonnet.
- The installation process is now complete and your tuning module is ready for use.
- Take your car for a test drive.



# 3 Installation

## Last step – Pair the tuning module with your smartphone

According to your operating system (**Android** and **Apple**), the steps for connecting the tuning module and your smartphone may vary. Please find the most important steps below. In general, you should follow the instructions given by your smartphone for the connection.

**i**

- The connection between the tuning module and your smartphone is set up in the last step of the installation process.
- The tuning module is fully functional even if there is no connection to a smartphone running the Tuning Pro app.

**1** Download the free DINANTRONICS X app by scanning the appropriate QR code for your device below.



**2** Switch on the ignition of your car. **Do not** start the engine.

**3** Activate the Bluetooth function of your smartphone.



**4** Open the DINANTRONICS X app.



**5** With opening the DINANTRONICS X app for the first time, the installation dialogue for chip tuning by tuning module is shown. Touch **ADD PRODUCT** and follow the instructions given by your smartphone.

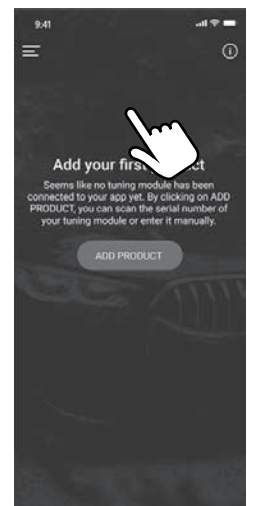

## 3 Installation

- 6** You can enter the serial number by hand (touch **MANUALLY**) or with the barcode scanner of the camera (touch ). Confirm the entry with **NEXT**.

**i**

The 13-digit serial number is located on the FCI connector of the tuning module. The Bluetooth PIN consists of the last 6 digits of the serial number.

**Example:**

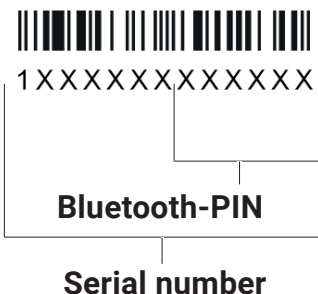

**Bluetooth-PIN**

**Serial number**

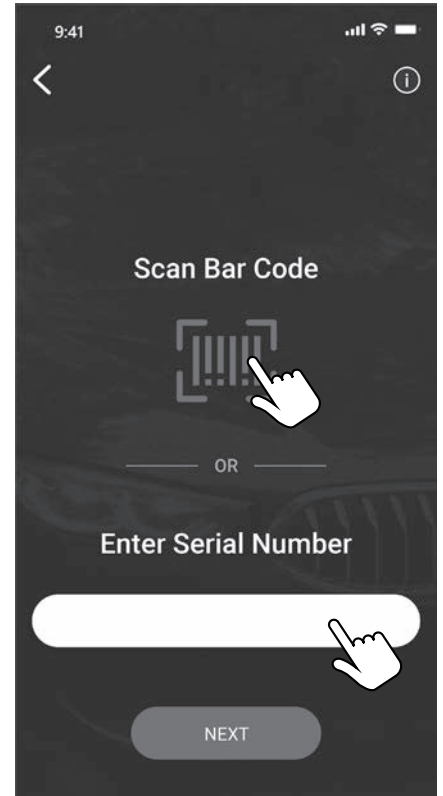

### **Having trouble with connecting your tuning module and your phone's Bluetooth?**

Follow these steps one by one until the pairing is complete:

- i**
1. Check that the car's ignition is switched on.
  2. Check that the Bluetooth function on your smartphone is fully activated.
  3. Check to see if the tuning module's Bluetooth connection is active (see **Overview of the tuning module**). If the Bluetooth symbol  is flashing or not lit, please contact our customer service.
  4. Deactivate and then re-activate the Bluetooth connection. Check if the tuning module and your phone will pair now.
  5. Re-start the Tuning Pro app.
  6. Go to your smartphone's settings and view all discoverable Bluetooth devices. If your tuning module (**DINANTRONICS X**) is not visible, please contact our customer service.

- 7** As soon as the connection is set up, the installation is completed.

## 4 Fine tuning

The performance upgrade has been calibrated specifically for the engine in your car, and further adjustment is generally not necessary in order to get the best performance. However, performance tolerances or the condition of the engine sometimes mean that Fine tuning is needed after installing the performance upgrade.

The Digital User Interface of the performance upgrade (see **Overview of the performance upgrade**) lets you carry out the Fine tuning yourself to get the best from your **Dinan**-enhanced engine.

Fine tuning may be necessary if the following occurs:



**Engine idles more roughly than in stock tune.**



Engine runs roughly, knocks or “pinks” under load, or the engine warning light comes on.



### **NOTICE**

The Fine tuning mappings can be changed using the +/- buttons only when the ignition is switched on but without the engine running.

- Mapping **5** is the factory setting.
- First activate Mapping **1**.
- Take your car for a test drive. If the engine performs as smoothly as you want, i.e. no hesitation or knocking, please activate Mapping **2** and go for another test drive.
- If the engine still performs as smoothly as you want, repeat the previous step.
- If the engine does not perform as smoothly as you want with one of the mappings, go back to the previous mapping – this is the right one for your engine.



If your engine does not run smoothly with any of the mappings or if the engine control light is permanently on after making all the adjustments (and after switching the ignition off and waiting 15 minutes), please contact our Customer Service (see **Contact** for details).

## 4 Fine tuning

### B

#### Making the enhanced performance more noticeable

### i

If the driver does not experience the extra performance, it means the driver cannot feel the difference from stock tuning.

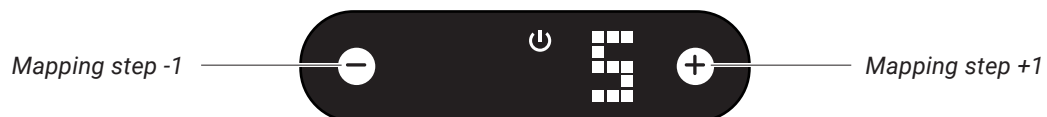

### NOTICE

The Fine tuning mappings can be changed using the +/- buttons only when the ignition is switched on but without the engine running.

- Mapping **5** is the factory setting.
- First activate Mapping **6**.
- Take your car for a test drive. Activate Mapping **7** only if you do not experience the enhanced performance strongly enough.
- If the engine does not perform as smoothly as you want, activate the next mapping down the scale (e.g. from **6** to **5**).

### NOTICE

For optimum performance, please use 93 octane fuel when driving in Mapping 6 or 7 (gasoline cars only) .

### i

- **Mapping 0** puts the engine into stock tune with the performance upgrade installed.
- You can also use the **deactivation plug** to return you car to stock tune without having to remove the wiring harness. In order to use the deactivation plug, you need to remove the performance upgrade from the wiring harness connector and replace it with the deactivation plug.
- Before replacing the performance upgrade with the deactivation plug, first ensure that there is no residual charge in the car's electrics (see **Step 1**).

# 5 Trouble Shooting

If the Performance upgrade does not function as it should, you can find some initial assistance here. If the suggestions here do not solve the problem, please contact our Customer Service (see **Contact**).

**NOTICE** If you do not wait for at least 10 minutes after locking your car, electrical voltage and signal flow may still be present in the connections. Detaching the connectors while electronic signals still flow, may damage your vehicle.

**NOTICE** Using 3rd-party on-board diagnostic (OBD) scan tools may damage your vehicle. Do not use them. **Dinan** is not liable for damages caused by any 3rd party OBD system.

Description of problem	What to do
<b>No extra performance or performance not noticeable enough</b> I am not satisfied with the performance level of my vehicle.	<ul style="list-style-type: none"><li>You can find detailed instructions on how to make the extra performance more noticeable in <b>Fine tuning</b> (section <b>B</b>).</li></ul>
<b>Knocking/ rattling</b> The engine knocks or rattles (diesel engine) more under load. It runs less smoothly than in stock tune.	<ul style="list-style-type: none"><li>If you have the impression that your engine knocks or rattles more than in stock tune, please take the car for a few test drives to be sure that your first impression was right. On the test drive, pay special attention to the engine's behaviour under load – the performance upgrade only works then.</li><li>If your first impression was right, you can find detailed instructions on how to make the engine run smoothly again in <b>Fine tuning</b> (section <b>A</b>).</li><li>If the knocking/rattling is very noticeable, you can carry out the steps described in <b>Fine tuning</b> immediately.</li></ul>
<b>Jolting</b> With the erformance upgrade installed, my car jolts, stutters or hesitates in situations where it did not before.	<ul style="list-style-type: none"><li>You can find detailed instructions on how to make the engine run smoothly again in <b>Fine tuning</b> (section <b>A</b>).</li><li>If that does not cure the problem, please contact our Customer Service; if you can describe the circumstances when the problem occurs, our Customer Service can make further adjustments.</li></ul>
<b>Quality of gear shift reduced</b> The shift behaviour and/or the shift quality has worsened since the installation of the performance upgrade. The gearbox sometimes cannot seem to find the right gear.	<ul style="list-style-type: none"><li>Select the next lowest mapping (see <b>Fine tuning</b>, section <b>A</b>). Repeat this procedure until you are happy with the gear shifting.</li><li>If that does not cure the problem, please contact our Customer Service; if you can describe the circumstances when the problem occurs, our Customer Service can make further adjustments.</li></ul>

# 5 Trouble Shooting

Description of problem	What to do
<p data-bbox="142 454 448 595"><b>Engine fault light or other warning light comes on and stays on after installing the performance upgrade.</b></p> <p data-bbox="142 607 499 748">A warning light on the dashboard comes on and stays on after installation of the performance upgrade.</p> <div data-bbox="142 775 400 842">The image contains two simple line-art icons. On the left is an icon of an engine block with a valve on top. On the right is an icon of two eyes, representing a warning light on a dashboard.</div>	<ul data-bbox="568 454 1442 1429" style="list-style-type: none"><li>• If a warning light (e.g engine fault light) comes on, it does not automatically mean something is wrong with the engine. The lamp can simply be a measure programmed by the manufacturer to protect the engine; it can be triggered if a cable is disconnected from a sensor when there was still power in the system, for instance. (One indication is if the Power On control lamp (see <b>Overview of the performance upgrade</b>) lit up as soon as the wiring harness was connected; it should light up only when the ignition is switched on). Please follow the steps below carefully until you have found the cause of the warning lamp and fixed it.</li><li>• De-install the performance upgrade wiring harness to the point that you can reconnect all the connections in your car as they were before you started installing the performance upgrade. Lock the car and wait ca. 30 minutes before starting the engine. If the warning light still stays on, stopping and restarting the engine several times or waiting for even longer can sometimes help.</li><li>• If the warning lights have gone out, you can re-install the performance upgrade. Make sure the ignition is off and wait at least 15 minutes before disconnecting the sensors. When the installation is complete, double check all the connections to ensure the connectors are joined correctly and tightly. Please connect the Deactivation plug to the wiring harness and start the engine again.</li><li>• If the warning lights do not come on, switch off the engine again and wait for 15 minutes. You can now replace the Deactivation plug with the performance upgrade and start the engine again.</li><li>• If the warning lights come on again now, please contact our Customer Service (see <b>Contact</b>).</li></ul>
<p data-bbox="142 1514 320 1541"><b>Soot generation</b></p> <p data-bbox="142 1552 489 1655">My car produces (more) soot since installing the performance upgrade.</p>	<ul data-bbox="568 1514 1401 1617" style="list-style-type: none"><li>• You can find detailed instructions on how to make the engine run smoothly again in <b>Fine tuning</b> (section <b>A</b>). The steps will also help stop the engine producing excess soot.</li></ul>

# 5 Trouble Shooting

---

Description of problem	What to do
<p><b>The car does not start</b> The car's ignition does not work after installing the performance upgrade.</p>	<ul style="list-style-type: none"><li>• Something probably went wrong during the installation procedure. Please follow the steps below to check that the performance upgrade is installed correctly.</li><li>• De-install the performance upgrade wiring harness the point that you can reconnect all the connections in your car as they were before you started installing the performance upgrade. (You can leave the wiring harness in the engine bay; the important thing is that it is not connected to the vehicle electrics). Lock the car and wait ca. 30 minutes before trying to start the engine again.</li><li>• If the car starts, you can re-install the performance upgrade. Make sure the ignition is switched off and wait at least 15 minutes before disconnecting the sensors in the engine bay. After installing the performance upgrade, double check that all the connectors are correctly and firmly fixed. Go through all the steps described in Installation again. Finally, start the engine.</li><li>• If the car still does not start, please contact our Customer Service (see <b>Contact</b>).</li></ul>
<p><b>No noticeable fuel savings</b> I do not notice any fuel savings</p>	<ul style="list-style-type: none"><li>• Make sure you are comparing before-and-after fuel consumption based on the vehicle's actual consumption – on-board computers often display incorrect values.</li><li>• It is important that your driving style remains the same, i.e. you do not accelerate harder or drive fast more often than before. You will not see any fuel savings either if you often drive at or near maximum load – you need to adopt an economical driving style at least some of the time in order to save fuel.</li><li>• If your driving style matches the description but you still do not see any fuel savings, please select the next highest mapping (see <b>Fine tuning</b>, section <b>B</b>). After selecting a new mapping, check the actual consumption to see if there has been any reduction.</li></ul>

---

# Detaching the connector correctly

If you have problems identifying your serial plug, you will find a list of all relevant plugs for your vehicle here.



**CAUTION:** If you use too much force your finger may slip off. This could cause injuries. Do not use force to release the connector and please proceed with caution to avoid injuries.



**NOTICE:** Using force or pulling at the cable may damage the connector or the locking clip. Do not use force to release the connector. Pull the plug, not the cable.

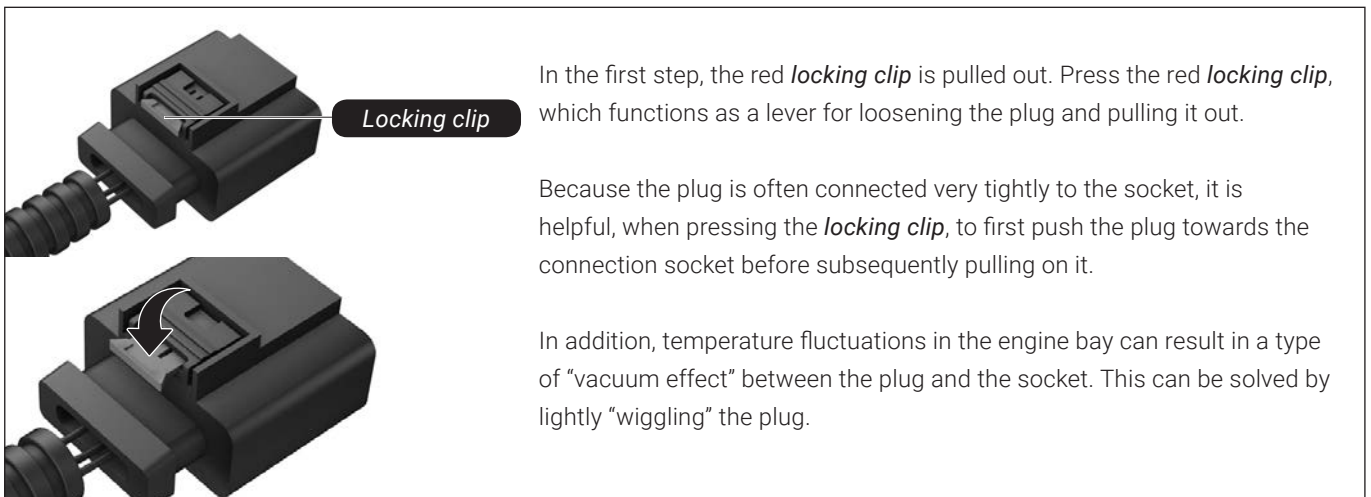

In the first step, the red *locking clip* is pulled out. Press the red *locking clip*, which functions as a lever for loosening the plug and pulling it out.

Because the plug is often connected very tightly to the socket, it is helpful, when pressing the *locking clip*, to first push the plug towards the connection socket before subsequently pulling on it.

In addition, temperature fluctuations in the engine bay can result in a type of “vacuum effect” between the plug and the socket. This can be solved by lightly “wiggling” the plug.

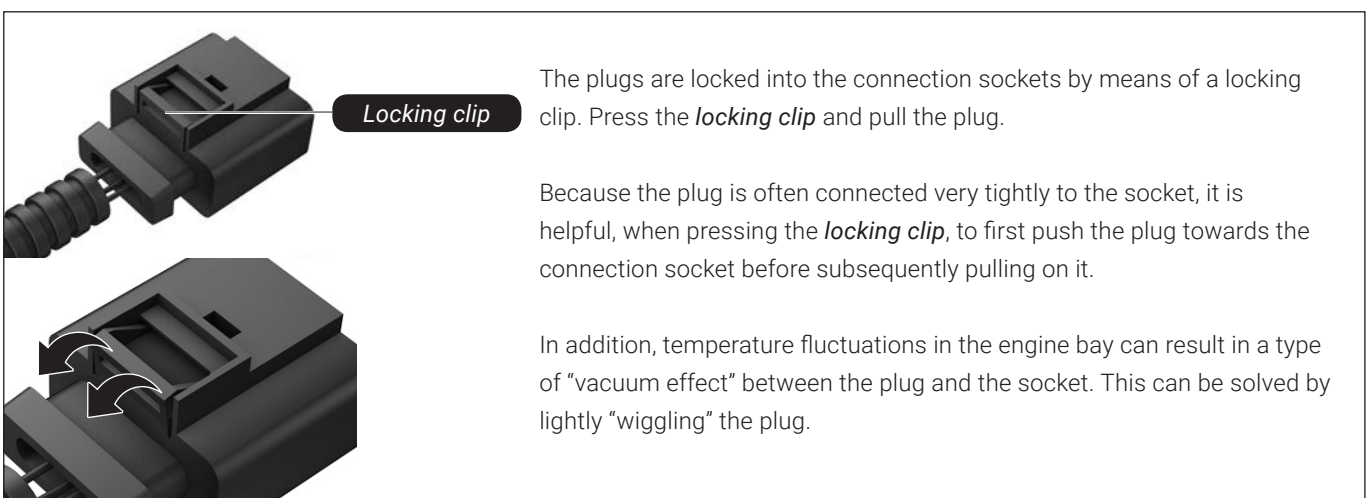

The plugs are locked into the connection sockets by means of a locking clip. Press the *locking clip* and pull the plug.

Because the plug is often connected very tightly to the socket, it is helpful, when pressing the *locking clip*, to first push the plug towards the connection socket before subsequently pulling on it.

In addition, temperature fluctuations in the engine bay can result in a type of “vacuum effect” between the plug and the socket. This can be solved by lightly “wiggling” the plug.



# Detaching the connector correctly

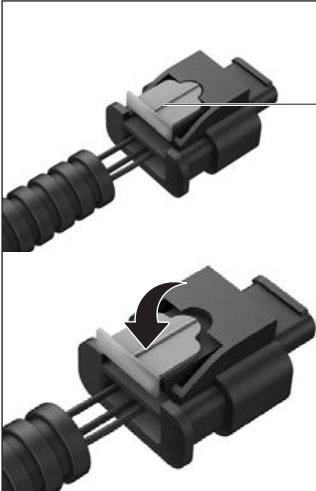

**Locking clip**

The first step involves pulling out the bright grey *locking clip*. Press down on the bright grey *locking clip*, which serves as a switch for releasing and removing the plug.

Because the plug is often connected very tightly to the socket, it is helpful, when pressing the *locking clip*, to first push the plug towards the connection socket before subsequently pulling on in.

In addition, temperature fluctuations in the engine bay can result in a type of "vacuum effect" between the plug and the socket. This can be solved by lightly "wiggling" the plug.

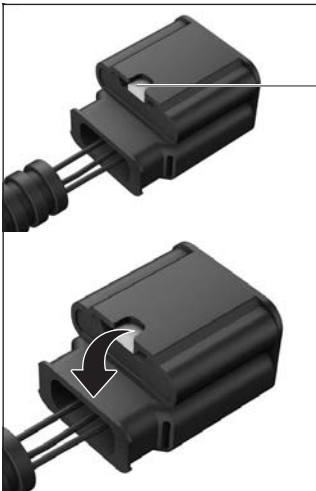

**Locking clip**

The plugs are locked into the connection sockets by means of a locking clip. Press the *locking clip* and pull the plug.

Because the plug is often connected very tightly to the socket, it is helpful, when pressing the *locking clip*, to first push the plug towards the connection socket before subsequently pulling on it.

In addition, temperature fluctuations in the engine bay can result in a type of "vacuum effect" between the plug and the socket. This can be solved by lightly "wiggling" the plug.

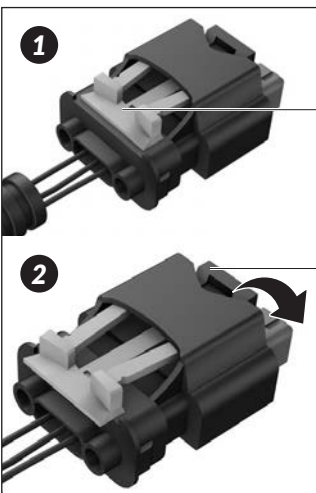

**1**

**Locking clip 1**

In the first step, the orange *locking clip 1* is pulled out. Press the black *locking clip 2*, which functions as a lever for loosening the plug and pulling it out.

**2**

**Locking clip 2**

Because the plug is often connected very tightly to the socket, it is helpful, when pressing the *locking clip*, to first push the plug towards the connection socket before subsequently pulling on it.

In addition, temperature fluctuations in the engine bay can result in a type of "vacuum effect" between the plug and the socket. This can be solved by lightly "wiggling" the plug.

# Detaching the connector correctly

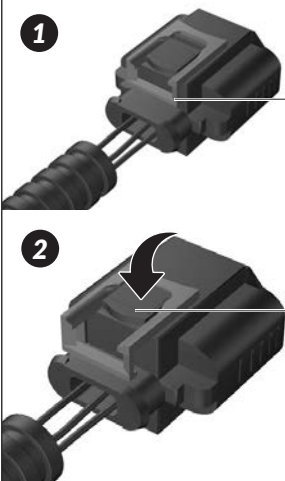

**1**

**Locking clip 1**

In the first step, the red *locking clip* 1 is pulled out. Press the black *locking clip* 2, which functions as a lever for loosening the plug and pulling it out.

Because the plug is often connected very tightly to the socket, it is helpful, when pressing the *locking clip*, to first push the plug towards the connection socket before subsequently pulling on it.

**2**

**Locking clip 2**

In addition, temperature fluctuations in the engine bay can result in a type of "vacuum effect" between the plug and the socket. This can be solved by lightly "wiggling" the plug.

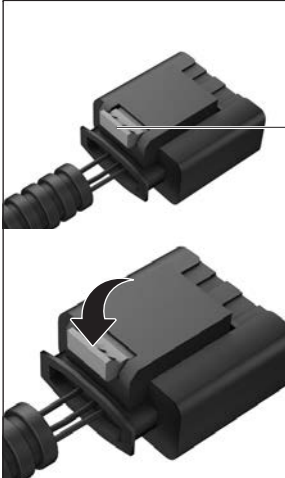

**Locking clip**

In the first step, the grey *locking clip* is pulled out. Press the grey *locking clip*, which functions as a lever for loosening the plug and pulling it out.

Because the plug is often connected very tightly to the socket, it is helpful, when pressing the *locking clip*, to first push the plug towards the connection socket before subsequently pulling on it.

In addition, temperature fluctuations in the engine bay can result in a type of "vacuum effect" between the plug and the socket. This can be solved by lightly "wiggling" the plug.

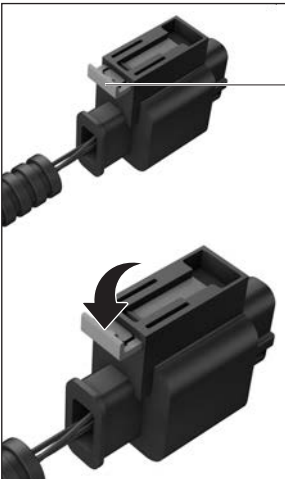

**Locking clip**

In the first step, the grey *locking clip* is pulled out. Press the grey *locking clip*, which functions as a lever for loosening the plug and pulling it out.

Because the plug is often connected very tightly to the socket, it is helpful, when pressing the *locking clip*, to first push the plug towards the connection socket before subsequently pulling on it.

In addition, temperature fluctuations in the engine bay can result in a type of "vacuum effect" between the plug and the socket. This can be solved by lightly "wiggling" the plug.

# Detaching the connector correctly



**Locking clip**

The plugs are locked into the connection sockets by means of a **locking clip**. Press the **locking clip** and pull the plug.

Because the plug is often connected very tightly to the socket, it is helpful, when pressing the **locking clip**, to first push the plug towards the connection socket before subsequently pulling on it.

In addition, temperature fluctuations in the engine bay can result in a type of “vacuum effect” between the plug and the socket. This can be solved by lightly “wiggling” the plug.

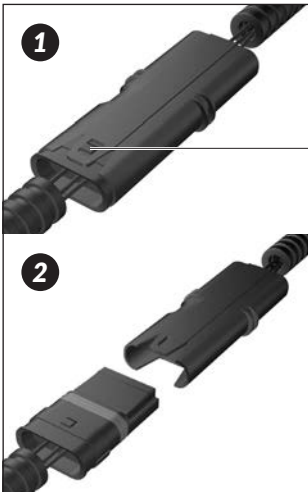

**1**

**Locking clip**

The plugs are locked into the connection sockets by means of a **locking clip**. Pull slightly the **locking clip** and pull the plug.

Because the plug is often connected very tightly to the socket, it is helpful, when pressing the **locking clip**, to first push the plug towards the connection socket before subsequently pulling on it.

**2**

In addition, temperature fluctuations in the engine bay can result in a type of “vacuum effect” between the plug and the socket. This can be solved by lightly “wiggling” the plug.

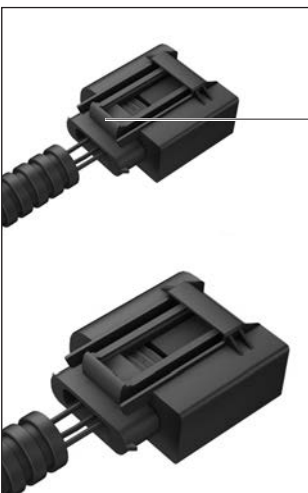

**Locking clip**

The plugs are locked into the connection sockets by means of a **locking clip**. Press the locking clip and pull the plug.

Because the plug is often connected very tightly to the socket, it is helpful, when pressing the **locking clip**, to first push the plug towards the connection socket before subsequently pulling on it.

In addition, temperature fluctuations in the engine bay can result in a type of “vacuum effect” between the plug and the socket. This can be solved by lightly “wiggling” the plug.

# Detaching the connector correctly

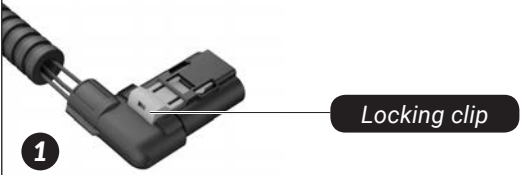

**1**

**Locking clip**

In the first step, the orange *locking clip* is pulled out. Press the orange *locking clip*, which functions as a lever for loosening the plug and pulling it out.

Because the plug is often connected very tightly to the socket, it is helpful, when pressing the *locking clip*, to first push the plug towards the connection socket before subsequently pulling on it.

In addition, temperature fluctuations in the engine bay can result in a type of “vacuum effect” between the plug and the socket. This can be solved by lightly “wiggling” the plug.



**2**

**Locking clip**

The plugs are locked into the connection sockets by means of a *locking clip*. Press the *locking clip* and pull the plug.

Because the plug is often connected very tightly to the socket, it is helpful, when pressing the *locking clip*, to first push the plug towards the connection socket before subsequently pulling on it.

In addition, temperature fluctuations in the engine bay can result in a type of “vacuum effect” between the plug and the socket. This can be solved by lightly “wiggling” the plug.

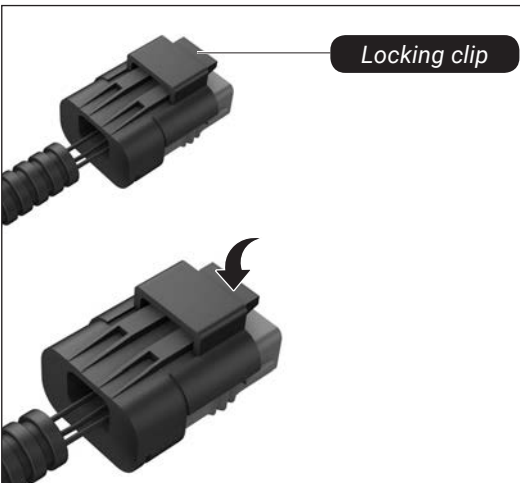

**Locking clip**

The plugs are locked into the connection sockets by means of a *locking clip*. Press the *locking clip* and pull the plug.

Because the plug is often connected very tightly to the socket, it is helpful, when pressing the *locking clip*, to first push the plug towards the connection socket before subsequently pulling on it.

In addition, temperature fluctuations in the engine bay can result in a type of “vacuum effect” between the plug and the socket. This can be solved by lightly “wiggling” the plug.

# Detaching the connector correctly

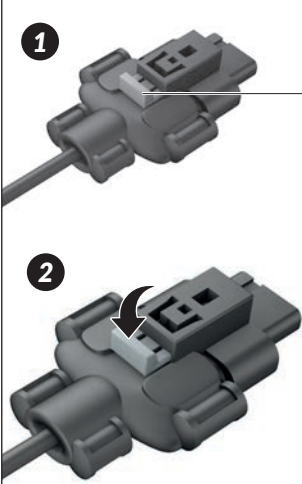

**1**

**Locking clip**

The first step involves pulling out the bright grey *locking clip*. Press down on the bright grey *locking clip*, which serves as a switch for releasing and removing the plug.

**2**

Because the plug is often connected very tightly to the socket, it is helpful, when pressing the *locking clip*, to first push the plug towards the connection socket before subsequently pulling on in.

In addition, temperature fluctuations in the engine bay can result in a type of “vacuum effect” between the plug and the socket. This can be solved by lightly “wiggling” the plug.

**Your plug is not listed?** Please contact our Customer Service staff.